

zü⁺® ZIIPLUS

FURNITURE HARDWARE

WE DESIGN, WE PRODUCE, WE INNOVATE

PRODUCT CATALOGUE

Full Pullout Soft-stop Magic Corner

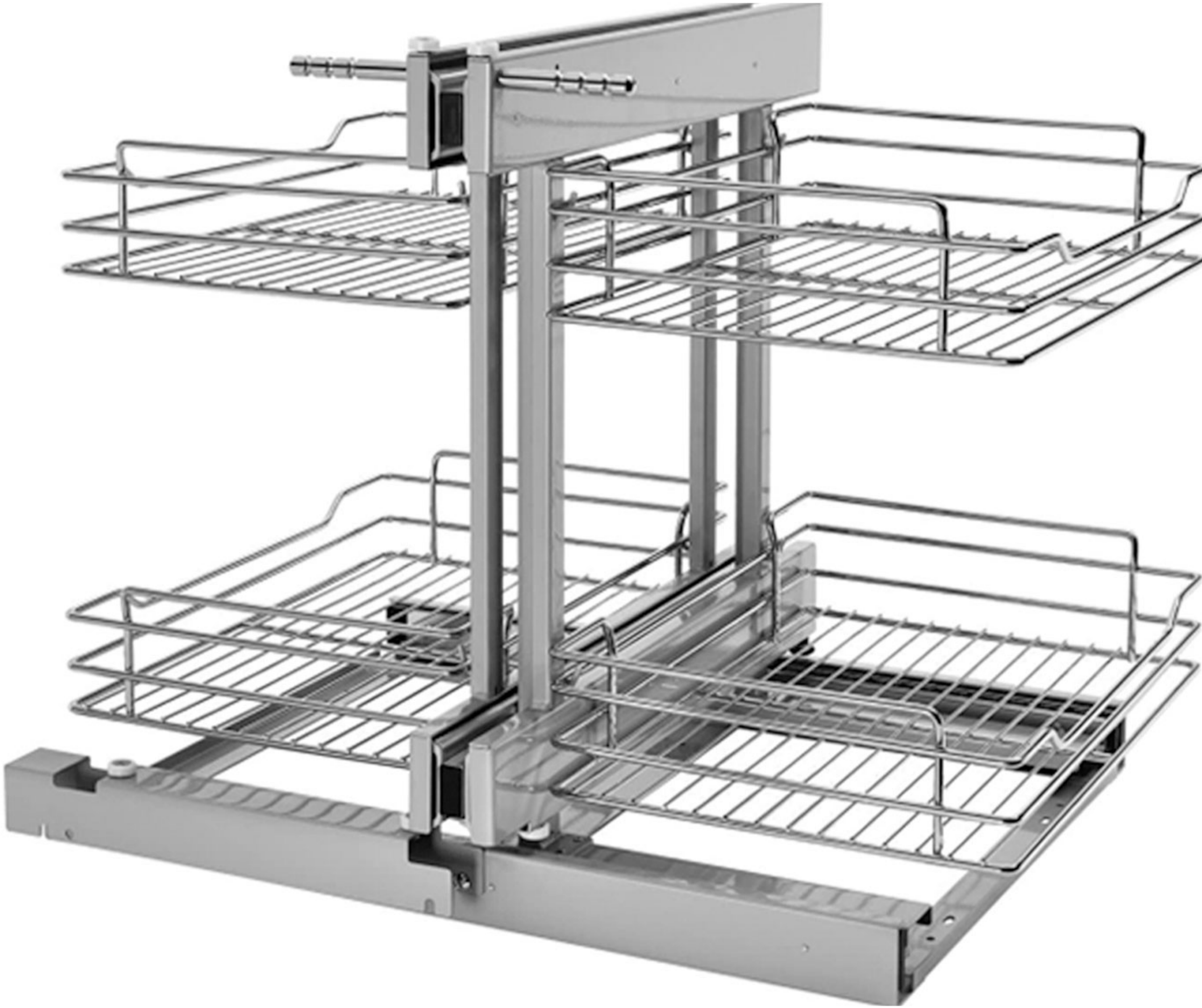

Item No.	Material	Surface Treatment	Specification D*W*H(mm)
型号	材质	表面处理	规格
ZTR-90F	195/201/304	CP/EL/NM/TH	485*660*590
ZTR-100F	195/201/304	CP/EL/NM/TH	585*660*590

Cabinet(mm)	CBM(1SET/M3)
柜体	体积
900	0.078
1000	0.09

Iron 铁 - 195
Stainless Steel 不锈钢 - 201/304
Chrome 电镀 - CP
Electrolysis 电解 - EL
Nano Plating 纳米干镀 - NM
Powder Coating: Dark Grey 碳灰 - TH

Left/Right Pullout Soft-stop Magic Corner



Item No.	Material	Surface Treatment	Specification D*W*H(mm)
型号	材质	表面处理	规格
ZTR-90E	195/201/304	CP/EL/NM/TH	485*660*590
ZTR-100E	195/201/304	CP/EL/NM/TH	585*660*590
ZTR-120E	195/201/304	CP/EL/NM/TH	785*660*590

Cabinet(mm)	CBM(1SET/M3)
柜体	体积
900	0.078
1000	0.09
1200	0.09

Iron 铁 - 195
Stainless Steel 不锈钢 - 201/304
Chrome 电镀 - CP
Electrolysis 电解 - EL
Nano Plating 纳米干镀 - NM
Powder Coating: Dark Grey 碳灰 - TH

Left/Right Pullout Soft-stop Magic Corner



Item No.	Material	Surface Treatment	Specification D*W*H(mm)
型号	材质	表面处理	规格
ZGR-90D(L/R)	195/201/304	CP/EL/NM/TH	498*860*516

Cabinet(mm)	CBM(1SET/M3)
柜体	体积
900	0.108

Iron 铁 - 195
Stainless Steel 不锈钢 - 201/304
Chrome 电镀 - CP
Electrolysis 电解 - EL
Nano Plating 纳米干镀 - NM
Powder Coating: Dark Grey 碳灰 - TH

Full Pullout Soft-stop Glass Magic Corner



Item No.	Material	Surface Treatment	Specification D*W*H(mm)
型号	材质	表面处理	规格
ZGS-80A(L/R)	195	TH	485*660*610

Cabinet(mm)	CBM(1SET/M3)
柜体	体积
800-900	0.2

Iron 铁 - 195
Powder Coating:
Dark Grey 碳灰 - TH

- Modular design, each tier height would be adjustable according to different goods.
- Max. load bearing of each layer is 10KG.
- Soft closing slides.

Left/Right Pullout Soft-stop Magic Corner



Item No.	Material	Surface Treatment	Specification D*W*H(mm)
型号	材质	表面处理	规格
ZTR-90A(L/R)	195/201/304	CP/EL/NM/TH	498*860*530
ZTR-90D(L/R)	195/201/304	CP/EL/NM/TH	498*860*530

Cabinet(mm)	CBM(1SET/M3)
柜体	体积
900	0.108
900	0.108

Iron 铁 - 195
Stainless Steel 不锈钢 - 201/304
Chrome 电镀 - CP
Electrolysis 电解 - EL
Nano Plating 纳米干镀 - NM
Powder Coating: Dark Grey 碳灰 - TH

Left/Right Pullout Soft-stop Board Magic Corner



Item No.	Material	Surface Treatment	Specification D*W*H(mm)
型号	材质	表面处理	规格
ZGS-90A (L/R)	195/201	CP/EL/NM/TH	498*860*530
ZWS-90A (L/R)	195/201	CP/EL/NM/TH	498*860*530

Cabinet(mm)	CBM(1SET/M3)
柜体	体积
900	0.11
900	0.11

Iron 铁 - 195
Stainless Steel 不锈钢 - 201/304
Chrome 电镀 - CP
Electrolysis 电解 - EL
Nano Plating 纳米干镀 - NM
Powder Coating: Dark Grey 碳灰 - TH

Full Pullout Anti-slip Board Magic Corner

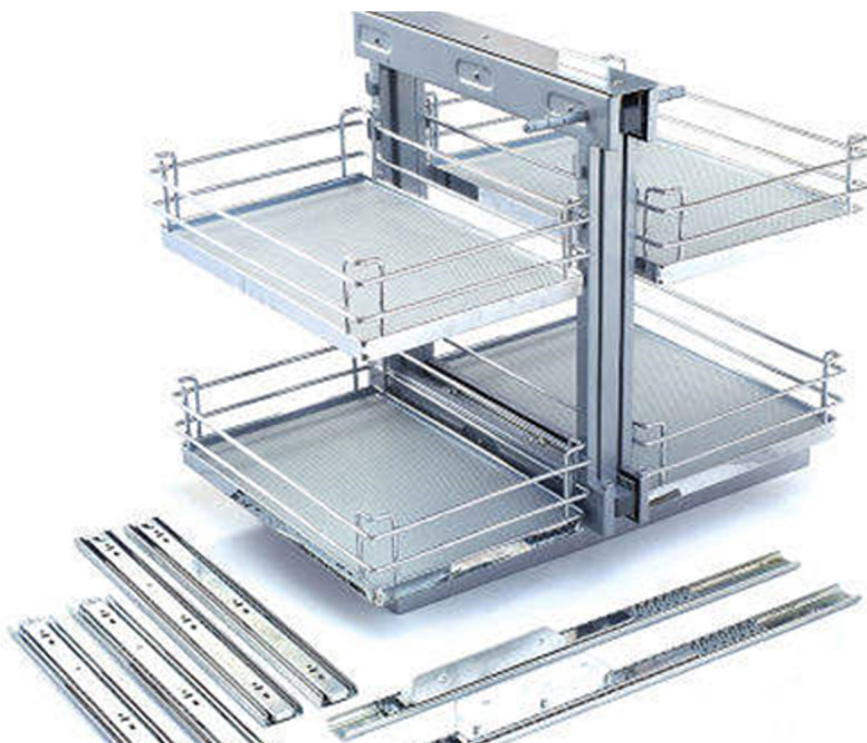

Item No.	Material	Surface Treatment	Specification D*W*H(mm)
型号	材质	表面处理	规格
ZGS-90C	195	CP/EL/NM/TH	498*860*590

Cabinet(mm)	CBM(1SET/M3)
柜体	体积
900	0.078

Iron 铁 - 195
Stainless Steel 不锈钢 - 201/304
Chrome 电镀 - CP
Electrolysis 电解 - EL
Nano Plating 纳米干镀 - NM
Powder Coating: Dark Grey 碳灰 - TH

Full Pullout Magic Corner



Item No.	Material	Surface Treatment	Specification D*W*H(mm)
型号	材质	表面处理	规格
ZTR-90C	195/201/304	CP/EL/NM/TH	498*860*516

Cabinet(mm)	CBM(1SET/M3)
柜体	体积
900	0.108

Iron 铁 - 195
Stainless Steel 不锈钢 - 201/304
Chrome 电镀 - CP
Electrolysis 电解 - EL
Nano Plating 纳米干镀 - NM
Powder Coating: Dark Grey 碳灰 - TH

Left/Right Pullout Soft-stop Metal Plate Magic Corner



Item No.	Material	Surface Treatment	Specification D*W*H(mm)
型号	材质	表面处理	规格
ZTVR-90E	195	NM/TH	498*980*530

Cabinet(mm)	CBM(1SET/M3)
柜体	体积
900	0.108

Iron 铁 - 195
Stainless Steel 不锈钢 - 201/304
Chrome 电镀 - CP
Electrolysis 电解 - EL
Nano Plating 纳米干镀 - NM
Powder Coating: Dark Grey 碳灰 - TH

Full Pullout Metal Plate Magic Corner



Item No.	Material	Surface Treatment	Specification D*W*H(mm)
型号	材质	表面处理	规格
ZTVR-90F	195	NM/TH	480*680*590

Cabinet(mm)	CBM(1SET/M3)
柜体	体积
900	0.078

Iron 铁 - 195
Stainless Steel 不锈钢 - 201/304
Chrome 电镀 - CP
Electrolysis 电解 - EL
Nano Plating 纳米干镀 - NM
Powder Coating: Dark Grey 碳灰 - TH

Soft-stop Swing Trays



Item No.	Material	Surface Treatment	Specification D*W*H(mm)
型号	材质	表面处理	规格
ZGS180A-900(L/R)	195	CP/NM/TH	825*370*600
ZWS180A-900(L/R)	195	CP/NM/TH	825*370*600
ZGS180B-900(L/R)	195	CP/NM/TH	825*370*600
ZWS180B-900(L/R)	195	CP/NM/TH	825*370*600

Cabinet(mm)	CBM(1SET/M3)
柜体	体积
900	0.083
900	0.083
900	0.083
900	0.083

A: Round Upper Wire 上框线-圆线
B: Flat Upper Wire 上框线-扁铁
GS: Gross Surface 光面面板
WS: Non-slip Surface 防滑面板

Iron 铁 - 195
Chrome 电镀 - CP
Nano Plating 纳米干镀 - NM
Powder Coating: Dark Grey 碳灰 - TH
GS: Gross Surface 光面面板
WS: Non-slip Surface 防滑面板

Soft-stop Swing Trays



Item No.	Material	Surface Treatment	Specification D*W*H(mm)
型号	材质	表面处理	规格
ZGS180B-1200(L/R)	195	CP/EL/NM/TH	925*390*600
ZWS180B-1200(L/R)	195	CP/EL/NM/TH	925*390*600

Cabinet(mm)	CBM(1SET/M3)
柜体	体积
1200	0.11
1200	0.11

A: Round Upper Wire 上框线-圆线
B: Flat Upper Wire 上框线-扁铁
GS: Gross Surface 光面面板
WS: Non-slip Surface 防滑面板

Iron 铁 - 195
Chrome 电镀 - CP
Nano Plating 纳米干镀 - NM
Powder Coating: Dark Grey 碳灰 - TH
GS: Gross Surface 光面面板
WS: Non-slip Surface 防滑面板

270° Revolving Magic Corner



Item No.	Material	Surface Treatment	Specification D*W*H(mm)
型号	材质	表面处理	规格
ZTR-270G	195/201/304	CP/EL/NM/TH	800*H(640-750)

Cabinet(mm)	CBM(1SET/M3)
柜体	体积
900	0.161

Iron 铁 - 195
Stainless Steel 不锈钢 - 201/304
Chrome 电镀 - CP
Electrolysis 电解 - EL
Nano Plating 纳米干镀 - NM
Powder Coating: Dark Grey 碳灰 - TH

270° Board Revolving Basket



Item No.	Material	Surface Treatment	Specification D*W*H(mm)
型号	材质	表面处理	规格
ZGS-270A	195	CP/NM/TH	710*H(565-790)

Cabinet(mm)	CBM(1SET/M3)
柜体	体积
800	0.073

Iron 铁 - 195
Stainless Steel 不锈钢 - 201/304
Chrome 电镀 - CP
Electrolysis 电解 - EL
Nano Plating 纳米干镀 - NM
Powder Coating: Dark Grey 碳灰 - TH

270° Revolving Basket



Item No.	Material	Surface Treatment	Specification D*W*H(mm)
ZTR-270A	195/201/304	CP/NM/TH	710*H(565-790)
ZTR-270B	195/201/304	CP/NM/TH	800*H(565-790)
ZTR-270C	195/201/304	CP/NM/TH	600*H(565-790)

Cabinet(mm)	CBM(1SET/M3)
800	0.073
900	0.092
700	0.052

Iron 铁 - 195
Stainless Steel 不锈钢 - 201/304
Chrome 电镀 - CP
Electrolysis 电解 - EL
Nano Plating 纳米干镀 - NM
Powder Coating: Dark Grey 碳灰 - TH

180° Revolving Basket



Item No.	Material	Surface Treatment	Specification D*W*H(mm)
型号	材质	表面处理	规格
ZTR-180A	195/201/304	CP/EL/NM/TH	φ745*565
ZTR-180C	195/201/304	CP/EL/NM/TH	φ680*565

Cabinet(mm)	CBM(1SET/M3)
柜体	体积
800	0.053
750	0.045

Iron 铁 - 195
Stainless Steel 不锈钢 - 201/304
Chrome 电镀 - CP
Electrolysis 电解 - EL
Nano Plating 纳米干镀 - NM
Powder Coating: Dark Grey 碳灰 - TH

360° Revolving Basket



Item No.	Material	Surface Treatment	Specification D*W*H(mm)
型号	材质	表面处理	规格
ZTR-360A	195/201/304	CP/EL/NM/TH	φ710*H(565-790)
ZTR-360B	195/201/304	CP/EL/NM/TH	φ820*H(565-790)
ZTR-360C	195/201/304	CP/EL/NM/TH	φ450*H(565-790)
ZTR-360D	195/201/304	CP/EL/NM/TH	φ500*H(565-790)
ZTR-360E	195/201/304	CP/EL/NM/TH	φ540*H(565-790)
ZTR-360F	195/201/304	CP/EL/NM/TH	φ600*H(565-790)

Cabinet(mm)	CBM(1SET/个)
柜体	体积
800	0.087
900	0.136
550	0.041
600	0.051
650	0.059
700	0.063

Iron 铁 - 195
 Stainless Steel 不锈钢 - 201/304
 Chrome 电镀 - CP
 Electrolysis 电解 - EL
 Nano Plating 纳米干镀 - NM
 Powder Coating: Dark Grey 碳灰 - TH

360° Revolving Basket



Item No.	Material	Surface Treatment	Specification D*W*H(mm)
ZLS7036-3-3	195/201/304	CP/EL/NM/TH	φ500*H(565-790)

Item No.	Material	Surface Treatment	Specification D*W*H(mm)
ZGS-360A	195	CP/NM/TH	φ710*H(565-790)

Cabinet(mm)	CBM(1SET/个)
600	0.077

Cabinet(mm)	CBM(1SET/个)
800	0.087

Iron 铁 - 195
 Stainless Steel 不锈钢 - 201/304
 Chrome 电镀 - CP
 Electrolysis 电解 - EL
 Nano Plating 纳米干镀 - NM
 Powder Coating: Dark Grey 碳灰 - TH

Soft-stop Pantry Unit



Item No.	Material	Surface Treatment	Specification D*W*H(mm)
型号	材质	表面处理	规格
ZTLM-904	195/201	CP/EL/NM/TH	780*530*(1320-1620)
ZTLM-905	195/201	CP/EL/NM/TH	780*530*(1620-1920)
ZTLM-906	195/201	CP/EL/NM/TH	780*530*(1920-2220)

Cabinet(mm)	CBM(1SET/M3)
柜体	体积
900	0.14
900	0.181
900	0.209

Iron 铁 - 195
 Stainless Steel 不锈钢 - 201/304
 Chrome 电镀 - CP
 Electrolysis 电解 - EL
 Nano Plating 纳米干镀 - NM
 Powder Coating: Dark Grey 碳灰 - TH

Soft-stop Tandem Pantry Unit (Wire/Board Basket)



Item No.	Material	Surface Treatment	Specification D*W*H(mm)
型号	材质	表面处理	规格
ZTGM-904	195/201	CP/EL/NM/TH	795*530*(1320-1620)
ZTGM-905	195/201	CP/EL/NM/TH	795*530*(1620-1920)
ZTGM-906	195/201	CP/EL/NM/TH	795*530*(1920-2220)

Cabinet(mm)	CBM(1SET/M3)
柜体	体积
900	0.122
900	0.152
900	0.182

Iron 铁 - 195
 Stainless Steel 不锈钢 - 201/304
 Chrome 电镀 - CP
 Electrolysis 电解 - EL
 Nano Plating 纳米干镀 - NM
 Powder Coating: Dark Grey 碳灰 - TH

Soft-stop Pantry Unit



Item No.	Material	Surface Treatment	Specification D*W*H(mm)
ZTLM-904	195/201	CP/EL/NM/TH	780*530*(1320-1620)
ZTLM-905	195/201	CP/EL/NM/TH	780*530*(1620-1920)
ZTLM-906	195/201	CP/EL/NM/TH	780*530*(1920-2220)

Cabinet(mm)	CBM(1SET/M3)
柜体	体积
900	0.14
900	0.161
900	0.209

Iron 铁 - 195
Stainless Steel 不锈钢 - 201/304
Chrome 电镀 - CP
Electrolysis 电解 - EL
Nano Plating 纳米干镀 - NM
Powder Coating: Dark Grey 碳灰 - TH

Soft-stop Tandem Pantry Unit (Wire/Board Basket)



Item No.	Material	Surface Treatment	Specification D*W*H(mm)
ZTGM-904	195/201	CP/EL/NM/TH	795*530*(1320-1620)
ZTGM-905	195/201	CP/EL/NM/TH	795*530*(1620-1920)
ZTGM-906	195/201	CP/EL/NM/TH	795*530*(1920-2220)

Cabinet(mm)	CBM(1SET/M3)
柜体	体积
900	0.122
900	0.152
900	0.182

Iron 铁 - 195
Stainless Steel 不锈钢 - 201/304
Chrome 电镀 - CP
Electrolysis 电解 - EL
Nano Plating 纳米干镀 - NM
Powder Coating: Dark Grey 碳灰 - TH

Soft-stop Half Tandem Pantry Unit



Item No.	Material	Surface Treatment	Specification D*W*H(mm)
型号	材质	表面处理	规格
ZTGM-604	195201	CP/EL/NM/TH	515*530*(1320-1620)
ZTGM-605	195201	CP/EL/NM/TH	515*530*(1620-1920)
ZTGM-606	195201	CP/EL/NM/TH	515*530*(1920-2220)
ZTGM-454	195201	CP/EL/NM/TH	365*530*(1320-1620)
ZTGM-455	195201	CP/EL/NM/TH	365*530*(1620-1920)
ZTGM-456	195201	CP/EL/NM/TH	365*530*(1920-2220)

Cabinet(mm)	CBM(1SET/M3)
柜体	体积
600	0.093
600	0.117
600	0.14
450	0.061
450	0.076
450	0.091



Iron 铁 - 195
Stainless Steel 不锈钢 - 201/304
Chrome 电镀 - CP
Electrolysis 电解 - EL
Nano Plating 纳米干镀 - NM
Powder Coating: Dark Grey 碳灰 - TH

Soft-stop Tandam Board Pantry Unit



Item No.	Material	Surface Treatment	Specification D*W*H(mm)
型号	材质	表面处理	规格
ZTGB-604	195	CP/NM/TH	515*530*(1320-1620)
ZTGB-605	195	CP/NM/TH	515*530*(1620-1920)
ZTGB-606	195	CP/NM/TH	515*530*(1920-2220)
ZTGB-454	195	CP/NM/TH	365*530*(1320-1620)
ZTGB-455	195	CP/NM/TH	365*530*(1620-1920)
ZTGB-456	195	CP/NM/TH	365*530*(1920-2220)

Cabinet(mm)	CBM(1SET/M3)
柜体	体积
600	0.093
600	0.117
600	0.14
450	0.061
450	0.076
450	0.091

Iron 铁 - 195
Stainless Steel 不锈钢 - 201/304
Chrome 电镀 - CP
Electrolysis 电解 - EL
Nano Plating 纳米干镀 - NM
Powder Coating: Dark Grey 碳灰 - TH

Tall Unit Basket



Item No.	Material	Surface Treatment	Specification D*W*H(mm)
型号	材质	表面处理	规格
ZTDM-304	195/201	CP/ELNM/TH	505*240*(1220-1520)
ZTDM-305	195/201	CP/ELNM/TH	505*240*(1520-1850)
ZTDM-306	195/201	CP/ELNM/TH	505*240*(1920-2250)
ZTDM-404	195/201	CP/ELNM/TH	505*345*(1220-1520)
ZTDM-405	195/201	CP/ELNM/TH	505*345*(1520-1850)
ZTDM-406	195/201	CP/ELNM/TH	505*345*(1920-2250)
ZTDM-454	195/201	CP/ELNM/TH	505*395*(1220-1520)
ZTDM-455	195/201	CP/ELNM/TH	505*395*(1520-1850)
ZTDM-456	195/201	CP/ELNM/TH	505*395*(1920-2250)
ZTDM-504	195/201	CP/ELNM/TH	505*445*(1220-1520)
ZTDM-505	195/201	CP/ELNM/TH	505*445*(1520-1850)
ZTDM-506	195/201	CP/ELNM/TH	505*445*(1920-2250)

Cabinet(mm)	CBM(1SET/M3)
柜体	体积
300	0.085
300	0.098
300	0.105
400	0.086
400	0.1
400	0.118
450	0.087
450	0.11
450	0.12
500	0.101
500	0.125
500	0.139

Iron 铁 - 195
 Stainless Steel 不锈钢 - 201/304
 Chrome 电镀 - CP
 Electrolysis 电解 - EL
 Nano Plating 纳米干镀 - NM
 Powder Coating: Dark Grey 碳灰 - TH

Tall Unit Basket



Item No.	Material	Surface Treatment	Specification D*W*H(mm)
型号	材质	表面处理	规格
ZGDM-304	195/201	CP/ELNM/TH	505*240*(1220-1520)
ZGDM-305	195/201	CP/ELNM/TH	505*240*(1520-1850)
ZGDM-306	195/201	CP/ELNM/TH	505*240*(1920-2250)
ZGDM-404	195/201	CP/ELNM/TH	505*345*(1220-1520)
ZGDM-405	195/201	CP/ELNM/TH	505*345*(1520-1850)
ZGDM-406	195/201	CP/ELNM/TH	505*345*(1920-2250)
ZGDM-454	195/201	CP/ELNM/TH	505*395*(1220-1520)
ZGDM-455	195/201	CP/ELNM/TH	505*395*(1520-1850)
ZGDM-456	195/201	CP/ELNM/TH	505*395*(1920-2250)
ZGDM-504	195/201	CP/ELNM/TH	505*445*(1220-1520)
ZGDM-505	195/201	CP/ELNM/TH	505*445*(1520-1850)
ZGDM-506	195/201	CP/ELNM/TH	505*445*(1920-2250)

Cabinet(mm)	CBM(1SET/M3)
柜体	体积
300	0.085
300	0.098
300	0.105
400	0.086
400	0.1
400	0.118
450	0.087
450	0.11
450	0.12
500	0.101
500	0.125
500	0.139

Iron 铁 - 195
 Stainless Steel 不锈钢 - 201/304
 Chrome 电镀 - CP
 Electrolysis 电解 - EL
 Nano Plating 纳米干镀 - NM
 Powder Coating: Dark Grey 碳灰 - TH

Soft Close Dismountable Pull Out Basket



Item No.	Material	Surface Treatment	Specification D*W*H(mm)
型号	材质	表面处理	规格
ZTVH-200G	195	NM/TH	465*135*490
ZTVH-150G	195	NM/TH	465*105*490

Cabinet(mm)	CBM(1SET/M3)
柜体	体积
200	0.034
150	0.025

Iron 铁 - 195
Stainless Steel 不锈钢 - 201/304
Chrome 电镀 - CP
Electrolysis 电解 - EL
Nano Plating 纳米干镀 - NM
Powder Coating: Dark Grey 碳灰 - TH

Soft Close Dismountable Pull Out Basket



Item No.	Material	Surface Treatment	Specification D*W*H(mm)
型号	材质	表面处理	规格
ZTVH-500G	195	NM/TH	465*485*490
ZTVH-450G	195	NM/TH	465*385*490
ZTVH-400G	195	NM/TH	465*335*490
ZTVH-350G	195	NM/TH	465*285*490
ZTVH-300G	195	NM/TH	465*235*490
ZTVH-250G	195	NM/TH	465*185*490

Cabinet(mm)	CBM(1SET/M3)
柜体	体积
500	0.122
450	0.097
400	0.087
350	0.0764
300	0.066
250	0.054

Iron 铁 - 195
Stainless Steel 不锈钢 - 201/304
Chrome 电镀 - CP
Electrolysis 电解 - EL
Nano Plating 纳米干镀 - NM
Powder Coating: Dark Grey 碳灰 - TH

Soft Close Board Basket



Item No.	Material	Surface Treatment	Specification D*W*H(mm)
型号	材质	表面处理	规格
ZTVF-900	195	NM/TH	450*905*150
ZTVF-800	195	NM/TH	450*785*150
ZTVF-700	195	NM/TH	450*665*150
ZTVF-600	195	NM/TH	450*565*150
ZTVF-500	195	NM/TH	450*465*150
ZTVF-450	195	NM/TH	450*415*150
ZTVF-400	195	NM/TH	450*365*150

Cabinet(mm)	CBM(1SET/M3)
柜体	体积
900	0.056
800	0.056
700	0.049
600	0.041
500	0.034
450	0.034
400	0.026

Iron 铁 - 195
Stainless Steel 不锈钢 - 201/304
Chrome 电镀 - CP
Electrolysis 电解 - EL
Nano Plating 纳米干镀 - NM
Powder Coating: Dark Grey 碳灰 - TH

Soft Close Dismountable Pull Out Basket



Item No.	Material	Surface Treatment	Specification D*W*H(mm)
型号	材质	表面处理	规格
ZTVF-450G3	195	NM/TH	465*365*520
ZTVF-400G3	195	NM/TH	465*335*520
ZTVF-350G3	195	NM/TH	465*285*520
ZTVF-300G3	195	NM/TH	465*235*520
ZTVF-250G3	195	NM/TH	465*185*520
ZTVF-200G3	195	NM/TH	465*135*520
ZTVF-150G3	195	NM/TH	465*105*520

Cabinet(mm)	CBM(1SET/M3)
柜体	体积
450	0.101
400	0.088
350	0.075
300	0.062
250	0.049
200	0.036
150	0.023

Iron 铁 - 195
Stainless Steel 不锈钢 - 201/304
Chrome 电镀 - CP
Electrolysis 电解 - EL
Nano Plating 纳米干镀 - NM
Powder Coating: Dark Grey 碳灰 - TH

Soft Close Dismountable Pull Out Basket



Item No.	Material	Surface Treatment	Specification D*W*H(mm)
型号	材质	表面处理	规格
ZTVH-450D	195	NM/TH	465*385*490
ZTVH-400D	195	NM/TH	465*335*490
ZTVH-350D	195	NM/TH	465*285*490
ZTVH-300D	195	NM/TH	465*235*490
ZTVH-250D	195	NM/TH	465*185*490
ZTVH-200D	195	NM/TH	465*135*490
ZTVH-150D	195	NM/TH	465*105*490

Cabinet(mm)	CBM(1SET/M3)
柜体	体积
450	0.097
400	0.087
350	0.0764
300	0.066
250	0.054
200	0.0424
150	0.03

Iron 铁 - 195
 Stainless Steel 不锈钢 - 201/304
 Chrome 电镀 - CP
 Electrolysis 电解 - EL
 Nano Plating 纳米干镀 - NM
 Powder Coating: Dark Grey 碳灰 - TH

Soft Close Board 3 Tier Pull Out Basket



Item No.	Material	Surface Treatment	Specification D*W*H(mm)
型号	材质	表面处理	规格
ZTVH-450A	195	NM/TH	465*385*520
ZTVH-400A	195	NM/TH	465*335*520
ZTVH-350A	195	NM/TH	465*285*520
ZTVH-300A	195	NM/TH	465*235*520

Cabinet(mm)	CBM(1SET/M3)
柜体	体积
450	0.101
400	0.088
350	0.075
300	0.062

Iron 铁 - 195
 Stainless Steel 不锈钢 - 201/304
 Chrome 电镀 - CP
 Electrolysis 电解 - EL
 Nano Plating 纳米干镀 - NM
 Powder Coating: Dark Grey 碳灰 - TH



Multi-purpose Basket - Side Mounting

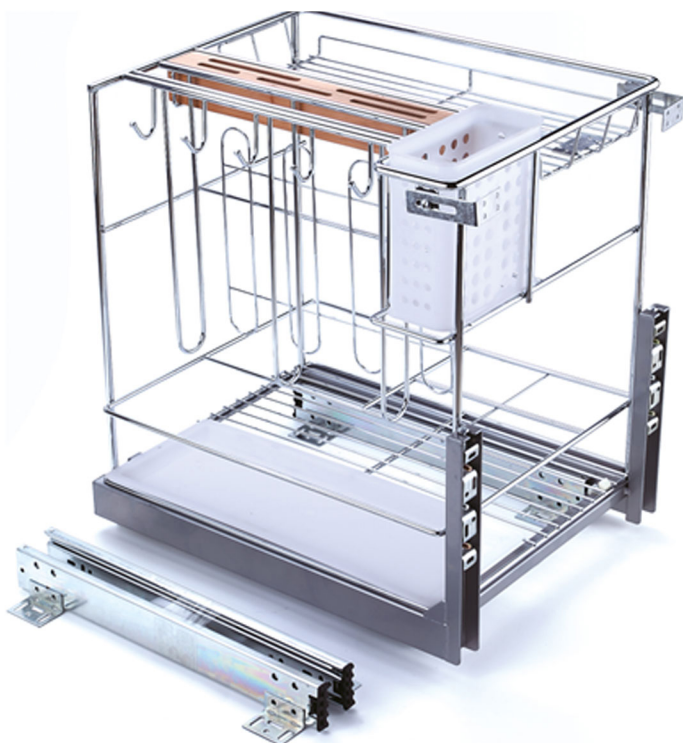

Item No.	Material	Surface Treatment	Specification D*W*H(mm)
型号	材质	表面处理	规格
ZTOT-400A	195/201/304	CPELNM/TH	450*350*465
ZTOT-350A	195/201/304	CPELNM/TH	450*300*465
ZTOT-300A	195/201/304	CPELNM/TH	450*250*465
ZTDM-400A	195/201/304	CPELNM/TH	450*350*480
ZTDM-350A	195/201/304	CPELNM/TH	450*300*480
ZTDM-300A	195/201/304	CPELNM/TH	450*250*480

Cabinet(mm)	CBM(1SET/M3)
柜体	体积
400	0.082
350	0.067
300	0.056
400	0.082
350	0.071
300	0.06

Iron 铁 - 195
 Stainless Steel 不锈钢 - 201/304
 Chrome 电镀 - CP
 Electrolysis 电解 - EL
 Nano Plating 纳米干镀 - NM
 Powder Coating: Dark Grey 碳灰 - TH
 TOT: Soft Close Slide 阻尼轨
 TDM: Normal Slide 普通三节轨

Multi-purpose Basket - Conceal Mounting



Item No.	Material	Surface Treatment	Specification D*W*H(mm)
型号	材质	表面处理	规格
ZTOB-400A	195/201/304	CPELNM/TH	435*350*465
ZTOB-350A	195/201/304	CPELNM/TH	435*300*465
ZTOB-300A	195/201/304	CPELNM/TH	435*250*465
ZTKM-400A	195/201/304	CPELNM/TH	435*350*480
ZTKM-350A	195/201/304	CPELNM/TH	435*300*480
ZTKM-300A	195/201/304	CPELNM/TH	435*250*480

Cabinet(mm)	CBM(1SET/M3)
柜体	体积
400	0.082
350	0.067
300	0.056
400	0.082
350	0.071
300	0.06

Iron 铁 - 195
 Stainless Steel 不锈钢 - 201/304
 Chrome 电镀 - CP
 Electrolysis 电解 - EL
 Nano Plating 纳米干镀 - NM
 Powder Coating: Dark Grey 碳灰 - TH
 TOB: Soft Close Slide 阻尼轨
 TKM: Normal Slide 普通三节轨

Multi-purpose Basket - Side Mounting

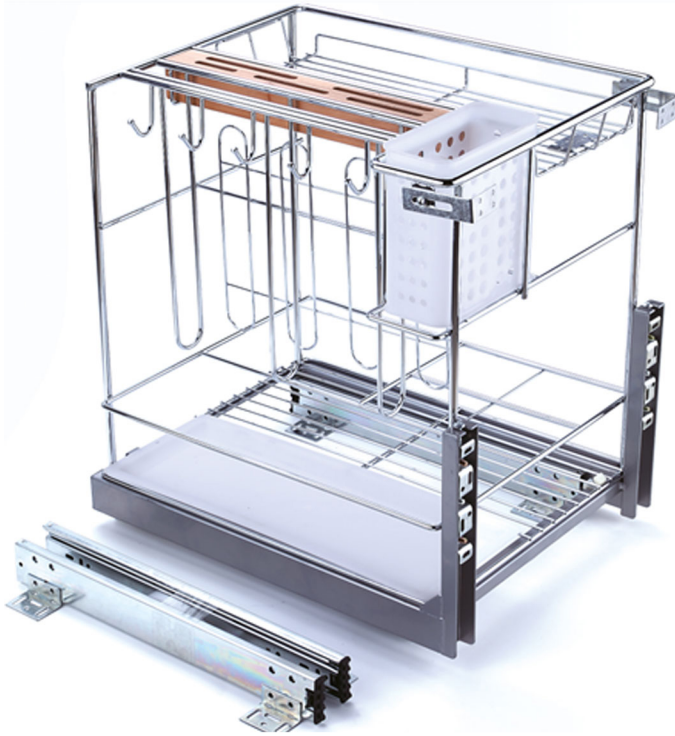

Item No.	Material	Surface Treatment	Specification D*W*H(mm)
型号	材质	表面处理	规格
TOT-400B	195/201/304	CP/EL/NM/TH	450*350*435
TOT-350B	195/201/304	CP/EL/NM/TH	450*300*435
TOT-300B	195/201/304	CP/EL/NM/TH	450*250*435
TDM-400B	195/201/304	CP/EL/NM/TH	450*345*450
TDM-350B	195/201/304	CP/EL/NM/TH	450*300*450
TDM-300B	195/201/304	CP/EL/NM/TH	450*250*450

Cabinet(mm)	CBM(1SET/M3)
柜体	体积
400	0.077
350	0.067
300	0.056
400	0.077
350	0.067
300	0.056

Iron 铁 - 195
 Stainless Steel 不锈钢 - 201/304
 Chrome 电镀 - CP
 Electrolysis 电解 - EL
 Nano Plating 纳米干镀 - NM
 Powder Coating: Dark Grey 碳灰 - TH
 TOT: Soft Close Slide 阻尼轨
 TDM: Normal Slide 普通三节轨

Multi-purpose Basket - Conceal Mounting



Item No.	Material	Surface Treatment	Specification D*W*H(mm)
型号	材质	表面处理	规格
ZTOB-400B	195/201/304	CP/EL/NM/TH	435*350*435
ZTOB-350B	195/201/304	CP/EL/NM/TH	435*300*435
ZTOB-300B	195/201/304	CP/EL/NM/TH	435*250*435
ZTKM-400B	195/201/304	CP/EL/NM/TH	435*345*450
ZTKM-350B	195/201/304	CP/EL/NM/TH	435*300*450
ZTKM-300B	195/201/304	CP/EL/NM/TH	435*250*450

Cabinet(mm)	CBM(1SET/M3)
柜体	体积
400	0.077
350	0.067
300	0.056
400	0.077
350	0.067
300	0.056

Iron 铁 - 195
 Stainless Steel 不锈钢 - 201/304
 Chrome 电镀 - CP
 Electrolysis 电解 - EL
 Nano Plating 纳米干镀 - NM
 Powder Coating: Dark Grey 碳灰 - TH
 TOB: Soft Close Slide 阻尼轨
 TKM: Normal Slide 普通三节轨

Soft-stop Multi-purpose Basket



Item No.	Material	Surface Treatment	Specification D*W*H(mm)
型号	材质	表面处理	规格
TOT-400N	195/201/304	CP/EL/NM/TH	450*350*595

Cabinet(mm)	CBM(1SET/M3)
柜体	体积
400	0.103

Iron 铁 - 195
Stainless Steel 不锈钢 - 201/304
Chrome 电镀 - CP
Electrolysis 电解 - EL
Nano Plating 纳米干镀 - NM
Powder Coating: Dark Grey 碳灰 - TH

Multi-purpose Basket



Item No.	Material	Surface Treatment	Specification D*W*H(mm)
型号	材质	表面处理	规格
ZTOT-200B	195/201/304	CP/EL/NM/TH	450*150*435
ZTDM-200B	195/201/304	CP/EL/NM/TH	450*150*450

Cabinet(mm)	CBM(1SET/M3)
柜体	体积
200	0.035
200	0.037

Iron 铁 - 195
Stainless Steel 不锈钢 - 201/304
Chrome 电镀 - CP
Electrolysis 电解 - EL
Nano Plating 纳米干镀 - NM
Powder Coating: Dark Grey 碳灰 - TH
TOT: Soft Close Slide 阻尼轨
TDM: Normal Slide 普通三节轨

Multi-purpose Basket



Item No.	Material	Surface Treatment	Specification D*W*H(mm)
型号	材质	表面处理	规格
ZTOB-200B	195/201/304	CP/EL/NM/TH	435*150*435
ZTKB-200B	195/201/304	CP/EL/NM/TH	435*150*450

Cabinet(mm)	CBM(1SET/M3)
柜体	体积
200	0.035
200	0.037

Iron 铁 - 195
Stainless Steel 不锈钢 - 201/304
Chrome 电镀 - CP
Electrolysis 电解 - EL
Nano Plating 纳米干镀 - NM
Powder Coating: Dark Grey 碳灰 - TH
TOB: Soft Close Slide 阻尼轨
TKB: Normal Slide 普通三节轨

Soft-stop Multifunctional Basket



Item No.	Material	Surface Treatment	Specification D*W*H(mm)
型号	材质	表面处理	规格
ZTOT-400H	195/201/304	CP/EL/NM/TH	457*338*490
ZTOT-350H	195/201/304	CP/EL/NM/TH	457*300*490
ZTOT-300H	195/201/304	CP/EL/NM/TH	457*245*490

Cabinet(mm)	CBM(1SET/M3)
柜体	体积
400	0.086
350	0.074
300	0.0623

Iron 铁 - 195
Stainless Steel 不锈钢 - 201/304
Chrome 电镀 - CP
Electrolysis 电解 - EL
Nano Plating 纳米干镀 - NM
Powder Coating: Dark Grey 碳灰 - TH

Multi-purpose Basket



Item No.	Material	Surface Treatment	Specification D*W*H(mm)
型号	材质	表面处理	规格
ZTOT-400D	195/201/304	CP/EL/NM/TH	450*350*435

Cabinet(mm)	CBM(1SET/M3)
柜体	体积
400	0.088

Iron 铁 - 195
Stainless Steel 不锈钢 - 201/304
Chrome 电镀 - CP
Electrolysis 电解 - EL
Nano Plating 纳米干镀 - NM
Powder Coating: Dark Grey 碳灰 - TH
TOT: Soft Close Slide 阻尼轨

Multi-purpose Basket



Item No.	Material	Surface Treatment	Specification D*W*H(mm)
型号	材质	表面处理	规格
ZTOB-400D	195/201/304	CP/EL/NM/TH	435*350*435

Cabinet(mm)	CBM(1SET/M3)
柜体	体积
400	0.088

Iron 铁 - 195
Stainless Steel 不锈钢 - 201/304
Chrome 电镀 - CP
Electrolysis 电解 - EL
Nano Plating 纳米干镀 - NM
Powder Coating: Dark Grey 碳灰 - TH
TOB: Normal Slide 普通三节轨

Multi-purpose Basket



Item No.	Material	Surface Treatment	Specification D*W*H(mm)
型号	材质	表面处理	规格
ZTOT-450B	195/201/304	CP/EL/NM/TH	450*400*435

Cabinet(mm)	CBM(1SET/M3)
柜体	体积
450	0.088

Iron 铁 - 195
Stainless Steel 不锈钢 - 201/304
Chrome 电镀 - CP
Electrolysis 电解 - EL
Nano Plating 纳米干镀 - NM
Powder Coating: Dark Grey 碳灰 - TH

Soft-stop Multi-purpose Square Wire Basket



Item No.	Material	Surface Treatment	Specification D*W*H(mm)
型号	材质	表面处理	规格
ZTOT-400S	195/201/304	CP/EL/NM/TH	450*350*510

Cabinet(mm)	CBM(1SET/M3)
柜体	体积
400	0.094

Iron 铁 - 195
Stainless Steel 不锈钢 - 201/304
Chrome 电镀 - CP
Electrolysis 电解 - EL
Nano Plating 纳米干镀 - NM
Powder Coating: Dark Grey 碳灰 - TH

Soft-stop Simple Board Basket



Item No.	Material	Surface Treatment	Specification D*W*H(mm)
型号	材质	表面处理	规格
ZGBH-200	195/201/304	CP/EL/NM/TH	475*150*535
ZGBH-300	195/201/304	CP/EL/NM/TH	475*250*535
ZGBH-400	195/201/304	CP/EL/NM/TH	475*350*535

Cabinet(mm)	CBM(1SET/M3)
柜体	体积
200	0.042
300	0.069
400	0.096

Iron 铁 - 195
Stainless Steel 不锈钢 - 201/304
Chrome 电镀 - CP
Electrolysis 电解 - EL
Nano Plating 纳米干镀 - NM
Powder Coating: Dark Grey 碳灰 - TH

Pull out Bread Basket



Item No.	Material	Surface Treatment	Specification D*W*H(mm)
型号	材质	表面处理	规格
ZTOM-300E	195/201/304	CP/EL/NM/TH	450*250*525
ZTOM-400E	195/201/304	CP/EL/NM/TH	450*350*525

Cabinet(mm)	CBM(1SET/M3)
柜体	体积
300	0.051
400	0.084

Iron 铁 - 195
Stainless Steel 不锈钢 - 201/304
Chrome 电镀 - CP
Electrolysis 电解 - EL
Nano Plating 纳米干镀 - NM
Powder Coating: Dark Grey 碳灰 - TH
TOT: Soft Close Slide 阻尼轨
TDM: Normal Slide 普通三节轨

Simple Basket



Item No.	Material	Surface Treatment	Specification D*W*H(mm)
型号	材质	表面处理	规格
ZTOT-400C	195/201/304	CP/EL/NM/TH	450*350*495
ZTOT-300C	195/201/304	CP/EL/NM/TH	450*250*495
ZTDH-400C	195/201/304	CP/EL/NM/TH	450*350*510
ZTDH-300C	195/201/304	CP/EL/NM/TH	450*250*510

Cabinet(mm)	CBM(1SET/个)
柜体	体积
400	0.087
300	0.063
400	0.087
300	0.063

Iron 铁 - 195
Stainless Steel 不锈钢 - 201/304
Chrome 电镀 - CP
Electrolysis 电解 - EL
Nano Plating 纳米干镀 - NM
Powder Coating: Dark Grey 碳灰 - TH
TOT: Soft Close Slide 阻尼轨
TDH: Normal Slide 普通三节轨

Simple Basket



Item No.	Material	Surface Treatment	Specification D*W*H(mm)
型号	材质	表面处理	规格
ZTOT-400M-S	195/201/304	CP/EL/NM/TH	470*365*480
ZTOT-350M-S	195/201/304	CP/EL/NM/TH	470*315*480

Cabinet(mm)	CBM(1SET/个)
柜体	体积
400	0.0823
350	0.071

Iron 铁 - 195
Stainless Steel 不锈钢 - 201/304
Chrome 电镀 - CP
Electrolysis 电解 - EL
Nano Plating 纳米干镀 - NM
Powder Coating: Dark Grey 碳灰 - TH

Simple Basket



Item No.	Material	Surface Treatment	Specification D*W*H(mm)
型号	材质	表面处理	规格
ZTOH-400A	195/201	CP/EL/NM/TH	450*350*520
ZTOH-350A	195/201	CP/EL/NM/TH	450*300*520
ZTOH-300A	195/201	CP/EL/NM/TH	450*255*500
ZTDH-400A	195/201	CP/EL/NM/TH	450*350*535
ZTDH-350A	195/201	CP/EL/NM/TH	450*300*535
ZTDH-300A	195/201	CP/EL/NM/TH	450*250*515

Cabinet(mm)	CBM(1SET/3)
柜体	体积
400	0.092
350	0.08
300	0.066
400	0.092
350	0.08
300	0.066

Iron 铁 - 195
Stainless Steel 不锈钢 - 201/304
Chrome 电镀 - CP
Electrolysis 电解 - EL
Nano Plating 纳米干镀 - NM
Powder Coating: Dark Grey 碳灰 - TH
TOH: Soft Close Slide 阻尼轨
TDH: Normal Slide 普通三节轨

Simple Basket



Item No.	Material	Surface Treatment	Specification D*W*H(mm)
型号	材质	表面处理	规格
ZTOM-400A	195/201	CP/EL/NM/TH	435*350*520
ZTOM-350A	195/201	CP/EL/NM/TH	435*300*520
ZTOM-300A	195/201	CP/EL/NM/TH	435*255*520
ZTKH-400A	195/201	CP/EL/NM/TH	435*350*515
ZTKH-350A	195/201	CP/EL/NM/TH	435*300*515
ZTKH-300A	195/201	CP/EL/NM/TH	435*250*515

Cabinet(mm)	CBM(1SET/3)
柜体	体积
400	0.092
350	0.08
300	0.066
400	0.093
350	0.08
300	0.066

Iron 铁 - 195
Stainless Steel 不锈钢 - 201/304
Chrome 电镀 - CP
Electrolysis 电解 - EL
Nano Plating 纳米干镀 - NM
Powder Coating: Dark Grey 碳灰 - TH
TOM: Soft Close Slide 阻尼轨
TKH: Normal Slide 普通三节轨

Simple Basket



Item No.	Material	Surface Treatment	Specification D*W*H(mm)
型号	材质	表面处理	规格
ZTOH-500A-2	195201	CP/EL/NM/TH	490*440*505
ZTOH-400A-2	195201	CP/EL/NM/TH	490*340*505
ZTOH-350A-2	195201	CP/EL/NM/TH	490*290*505
ZTOH-300A-2	195201	CP/EL/NM/TH	490*240*505
ZTOH-200A-2	195201	CP/EL/NM/TH	490*150*505
ZTOH-150A-2	195201	CP/EL/NM/TH	490*105*505
ZTDH-500A-2	195201	CP/EL/NM/TH	490*440*520
ZTDH-400A-2	195201	CP/EL/NM/TH	490*340*520
ZTDH-350A-2	195201	CP/EL/NM/TH	490*290*520
ZTDH-300A-2	195201	CP/EL/NM/TH	490*240*520
ZTDH-200A-2	195201	CP/EL/NM/TH	490*150*520
ZTDH-150A-2	195201	CP/EL/NM/TH	490*105*520

Cabinet(mm)	CBM(1SET/M3)
柜体	体积
500	0.126
400	0.099
350	0.085
300	0.072
200	0.045
150	0.031
500	0.126
400	0.099
350	0.085
300	0.072
200	0.045
200	0.031

Iron 铁 - 195
 Stainless Steel 不锈钢 - 201/304
 Chrome 电镀 - CP
 Electrolysis 电解 - EL
 Nano Plating 纳米干镀 - NM
 Powder Coating: Dark Grey 碳灰 - TH
 TOH: Soft Close Slide 阻尼轨
 TDH: Normal Slide 普通三节轨

Simple Basket



Item No.	Material	Surface Treatment	Specification D*W*H(mm)
型号	材质	表面处理	规格
ZTOM-500A-2	195201	CP/EL/NM/TH	559*280*300

Cabinet(mm)	CBM(1SET/M3)
柜体	体积
300	0.047

Iron 铁 - 195
 Stainless Steel 不锈钢 - 201/304
 Chrome 电镀 - CP
 Electrolysis 电解 - EL
 Nano Plating 纳米干镀 - NM
 Powder Coating: Dark Grey 碳灰 - TH
 TOM: Soft Close Slide 阻尼轨

Simple Basket - Side Mounting



Item No.	Material	Surface Treatment	Specification D*W*H(mm)
型号	材质	表面处理	规格
ZTOH-200C	195/201	CP/EL/NM/TH	450*150*475
ZTOH-150C	195/201	CP/EL/NM/TH	450*105*475
ZTDH-200C	195/201	CP/EL/NM/TH	450*150*490
ZTDH-150C	195/201	CP/EL/NM/TH	450*105*490

Cabinet(mm)	CBM(1SET/M3)
柜体	体积
200	0.038
150	0.028
200	0.038
150	0.028

Iron 铁 - 195
Stainless Steel 不锈钢 - 201/304
Chrome 电镀 - CP
Electrolysis 电解 - EL
Nano Plating 纳米干镀 - NM
Powder Coating: Dark Grey 碳灰 - TH
TOH: Soft Close Slide 阻尼轨
TDH: Normal Slide 普通三节轨

Simple Basket - Conceal Mounting



Item No.	Material	Surface Treatment	Specification D*W*H(mm)
型号	材质	表面处理	规格
ZTOM-200C	195/201	CP/EL/NM/TH	435*155*475
ZTOM-150C	195/201	CP/EL/NM/TH	435*105*475
ZTKH-200C	195/201	CP/EL/NM/TH	435*150*490
ZTKH-150C	195/201	CP/EL/NM/TH	435*105*490

Cabinet(mm)	CBM(1SET/M3)
柜体	体积
200	0.038
150	0.028
200	0.038
150	0.028

Iron 铁 - 195
Stainless Steel 不锈钢 - 201/304
Chrome 电镀 - CP
Electrolysis 电解 - EL
Nano Plating 纳米干镀 - NM
Powder Coating: Dark Grey 碳灰 - TH
TOM: Soft Close Slide 阻尼轨
TKH: Normal Slide 普通三节轨

Four-side Basket



Item No.	Material	Surface Treatment	Specification D*W*H(mm)
型号	材质	表面处理	规格
ZTOT-900E	195/201/304	CPELANMTH	440*985*130
ZTOT-800E	195/201/304	CPELANMTH	440*765*130
ZTOT-720E	195/201/304	CPELANMTH	440*685*130
ZTOT-700E	195/201/304	CPELANMTH	440*665*130
ZTOT-600E	195/201/304	CPELANMTH	440*565*130
ZTOT-500E	195/201/304	CPELANMTH	440*465*130
ZTOT-450E	195/201/304	CPELANMTH	440*415*130
ZTOT-400E	195/201/304	CPELANMTH	440*365*130
ZTDE-900B	195/201/304	CPELANMTH	440*985*130
ZTDE-800B	195/201/304	CPELANMTH	440*765*130
ZTDE-720B	195/201/304	CPELANMTH	440*685*130
ZTDE-700B	195/201/304	CPELANMTH	440*665*130
ZTDE-600B	195/201/304	CPELANMTH	440*565*130
ZTDE-500B	195/201/304	CPELANMTH	440*465*130
ZTDE-450B	195/201/304	CPELANMTH	440*415*130
ZTDE-400B	195/201/304	CPELANMTH	440*365*130

Cabinet(mm)	CBM(1SET/3)
柜体	体积
900	0.058
800	0.051
720	0.046
700	0.045
600	0.038
500	0.032
450	0.028
400	0.081
900	0.058
800	0.051
720	0.046
700	0.045
600	0.038
500	0.032
450	0.028
400	0.081

Iron 铁 - 195
 Stainless Steel 不锈钢 - 201/304
 Chrome 电镀 - CP
 Electrolysis 电解 - EL
 Nano Plating 纳米干镀 - NM
 Powder Coating: Dark Grey 碳灰 - TH
 TOT: Soft Close Slide 阻尼轨
 TDE: Normal Slide 普通三节轨

Four-side Dish Draining Basket



Item No.	Material	Surface Treatment	Specification D*W*H(mm)
型号	材质	表面处理	规格
ZTOT-900F	195/201/304	CPELANMTH	470*985*175
ZTOT-800F	195/201/304	CPELANMTH	470*765*175
ZTOT-720F	195/201/304	CPELANMTH	470*685*175
ZTOT-700F	195/201/304	CPELANMTH	470*665*175
ZTOT-600F	195/201/304	CPELANMTH	470*565*175
ZTOT-500F	195/201/304	CPELANMTH	470*465*175
ZTOT-450F	195/201/304	CPELANMTH	470*415*175
ZTOT-400F	195/201/304	CPELANMTH	470*365*175
ZTDF-900B	195/201/304	CPELANMTH	470*985*175
ZTDF-800B	195/201/304	CPELANMTH	470*765*175
ZTDF-720B	195/201/304	CPELANMTH	470*685*175
ZTDF-700B	195/201/304	CPELANMTH	470*665*175
ZTDF-600B	195/201/304	CPELANMTH	470*565*175
ZTDF-500B	195/201/304	CPELANMTH	470*465*175
ZTDF-450B	195/201/304	CPELANMTH	470*415*175
ZTDF-400B	195/201/304	CPELANMTH	470*365*175

Cabinet(mm)	CBM(1SET/3)
柜体	体积
900	0.073
800	0.064
720	0.057
700	0.055
600	0.047
500	0.038
450	0.034
400	0.03
900	0.073
800	0.064
720	0.057
700	0.055
600	0.047
500	0.038
450	0.034
400	0.03



Iron 铁 - 195
 Stainless Steel 不锈钢 - 201/304
 Chrome 电镀 - CP
 Electrolysis 电解 - EL
 Nano Plating 纳米干镀 - NM
 Powder Coating: Dark Grey 碳灰 - TH
 TOT: Soft Close Slide 阻尼轨
 TDF: Normal Slide 普通三节轨

Soft-stop Three-side Basket



Item No.	Material	Surface Treatment	Specification D*W*H(mm)
型号	材质	表面处理	规格
ZTDS-900F	195/201	CPELNMTH	440*985*150
ZTDS-800F	195/201	CPELNMTH	440*785*150
ZTDS-750F	195/201	CPELNMTH	440*735*150
ZTDS-720F	195/201	CPELNMTH	440*705*150
ZTDS-700F	195/201	CPELNMTH	440*685*150
ZTDS-600F	195/201	CPELNMTH	440*565*150

Cabinet(mm)	CBM(1SET/PCS)
柜体	体积
900	0.057
800	0.051
750	0.048
720	0.045
700	0.044
600	0.037

Iron 铁 - 195
Stainless Steel 不锈钢 - 201/304
Chrome 电镀 - CP
Electrolysis 电解 - EL
Nano Plating 纳米干镀 - NM
Powder Coating: Dark Grey 碳灰 - TH

Soft-stop Three-side Basket



Item No.	Material	Surface Treatment	Specification D*W*H(mm)
型号	材质	表面处理	规格
ZDTC-900B3	195/201/304	CPELNMTH	465*985*150
ZDTC-800B3	195/201/304	CPELNMTH	465*785*150
ZDTC-700B3	195/201/304	CPELNMTH	465*685*150
ZDTC-600B3	195/201/304	CPELNMTH	465*565*150

Cabinet(mm)	CBM(1SET/PCS)
柜体	体积
900	0.09
800	0.083
700	0.076
600	0.069

Iron 铁 - 195
Stainless Steel 不锈钢 - 201/304
Chrome 电镀 - CP
Electrolysis 电解 - EL
Nano Plating 纳米干镀 - NM
Powder Coating: Dark Grey 碳灰 - TH

Soft-stop Three-side Basket



Item No.	Material	Surface Treatment	Specification D*W*H(mm)
型号	材质	表面处理	规格
ZDTC-900D3	195/201/304	CP/EL/NM/TH	465*965*150
ZDTC-800D3	195/201/304	CP/EL/NM/TH	465*765*150
ZDTC-700D3	195/201/304	CP/EL/NM/TH	465*665*150
ZDTC-600D3	195/201/304	CP/EL/NM/TH	465*565*150
ZDTC-500D3	195/201/304	CP/EL/NM/TH	465*465*150
ZDTC-400D3	195/201/304	CP/EL/NM/TH	465*365*150

Cabinet(mm)	CBM(1SET/M3)
柜体	体积
900	0.09
800	0.083
700	0.076
600	0.069
500	0.062
400	0.055

Iron 铁 - 195
Stainless Steel 不锈钢 - 201/304
Chrome 电镀 - CP
Electrolysis 电解 - EL
Nano Plating 纳米干镀 - NM
Powder Coating: Dark Grey 碳灰 - TH

Soft-stop Three-side Basket



Item No.	Material	Surface Treatment	Specification D*W*H(mm)
型号	材质	表面处理	规格
ZDTC-900C3	195/201/304	CP/EL/NM/TH	465*965*150
ZDTC-800C3	195/201/304	CP/EL/NM/TH	465*765*150
ZDTC-700C3	195/201/304	CP/EL/NM/TH	465*665*150
ZDTC-600C3	195/201/304	CP/EL/NM/TH	465*565*150

Cabinet(mm)	CBM(1SET/M3)
柜体	体积
900	0.09
800	0.083
700	0.076
600	0.069

Iron 铁 - 195
Stainless Steel 不锈钢 - 201/304
Chrome 电镀 - CP
Electrolysis 电解 - EL
Nano Plating 纳米干镀 - NM
Powder Coating: Dark Grey 碳灰 - TH

Soft-stop Trough Basket



Item No.	Material	Surface Treatment	Specification D*W*H(mm)
型号	材质	表面处理	规格
ZTOT-350G	195/201	CP/EL/NM/TH	450*280*360

Cabinet(mm)	CBM(1SET/SET3)
柜体	体积
350	0.039

Iron 铁 - 195
Stainless Steel 不锈钢 - 201/304
Chrome 电镀 - CP
Electrolysis 电解 - EL
Nano Plating 纳米干镀 - NM
Powder Coating: Dark Grey 碳灰 - TH

Soft-stop Trough Basket



Item No.	Material	Surface Treatment	Specification D*W*H(mm)
型号	材质	表面处理	规格
ZTOT-1000A	195/201	CP/EL/NM/TH	470*965*150
ZTOT-900A	195/201	CP/EL/NM/TH	470*865*150

Cabinet(mm)	CBM(1SET/SET3)
柜体	体积
1000	0.135
900	0.119

Iron 铁 - 195
Stainless Steel 不锈钢 - 201/304
Chrome 电镀 - CP
Electrolysis 电解 - EL
Nano Plating 纳米干镀 - NM
Powder Coating: Dark Grey 碳灰 - TH

Normal Slide Pull Out Basket



Item No.	Material	Surface Treatment	Specification D*W*H(mm)
型号	材质	表面处理	规格
ZTDP-150A	195/201	CP/EL/NM/TH	440*105*435
ZTDP-200A	195/201	CP/EL/NM/TH	440*150*435
ZTDP-300A	195/201	CP/EL/NM/TH	440*245*430

Cabinet(mm)	CBM(1SET/3)
柜体	体积
150	0.024
200	0.033
300	0.059

Iron 铁 - 195
 Stainless Steel 不锈钢 - 201/304
 Chrome 电镀 - CP
 Electrolysis 电解 - EL
 Nano Plating 纳米干镀 - NM
 Powder Coating: Dark Grey 碳灰 - TH



Normal Slide Pull Out Basket



Item No.	Material	Surface Treatment	Specification D*W*H(mm)
型号	材质	表面处理	规格
ZTDP-300B	195/201	CP/EL/NM/TH	475*245*430
ZTDP-300BM	195/201	CP/EL/NM/TH	420*190*305

Cabinet(mm)	CBM(1SET/3)
柜体	体积
300	0.025
300	0.011

Iron 铁 - 195
 Stainless Steel 不锈钢 - 201/304
 Chrome 电镀 - CP
 Electrolysis 电解 - EL
 Nano Plating 纳米干镀 - NM
 Powder Coating: Dark Grey 碳灰 - TH



Normal Slide Pull Out Basket



Item No.	Material	Surface Treatment	Specification D*W*H(mm)
型号	材质	表面处理	规格
ZTDP-300E	195/201	CP/EL/NM/TH	480*250*415

Cabinet(mm)	CBM(1SET/M3)
柜体	体积
300	0.052

Iron 铁 - 195
 Stainless Steel 不锈钢 - 201/304
 Chrome 电镀 - CP
 Electrolysis 电解 - EL
 Nano Plating 纳米干镀 - NM
 Powder Coating: Dark Grey 碳灰 - TH



Normal Slide Trough Basket



Item No.	Material	Surface Treatment	Specification D*W*H(mm)
型号	材质	表面处理	规格
ZTDP-200D	195/201	CP/EL/NM/TH	480*150*545
ZTDP-250D	195/201	CP/EL/NM/TH	480*200*545
ZTDP-300D	195/201	CP/EL/NM/TH	480*250*545

Cabinet(mm)	CBM(1SET/M3)
柜体	体积
200	0.028
250	0.028
300	0.034

Iron 铁 - 195
 Stainless Steel 不锈钢 - 201/304
 Chrome 电镀 - CP
 Electrolysis 电解 - EL
 Nano Plating 纳米干镀 - NM
 Powder Coating: Dark Grey 碳灰 - TH

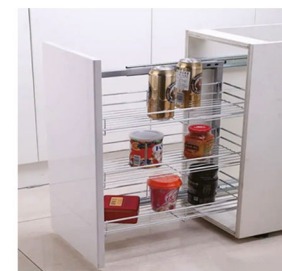

Soft Close Side Pull Out Basket



Item No.	Material	Surface Treatment	Specification D*W*H(mm)
型号	材质	表面处理	规格
ZTDP-200B(L/R)	195/201/304	CP/EL/NM/TH	450*150*535
ZTDP-150B(L/R)	195/201/304	CP/EL/NM/TH	450*100*535

Cabinet(mm)	CBM(1SET/M3)
柜体	体积
200	0.037
150	0.025

Iron 铁 - 195
 Stainless Steel 不锈钢 - 201/304
 Chrome 电镀 - CP
 Electrolysis 电解 - EL
 Nano Plating 纳米干镀 - NM
 Powder Coating: Dark Grey 碳灰 - TH



Soft Close Side Pull Out Basket



Item No.	Material	Surface Treatment	Specification D*W*H(mm)
型号	材质	表面处理	规格
ZSMB15A	195	CP	460*110*565
ZSMB20A	195	CP	460*150*565

Cabinet(mm)	CBM(1SET/M3)
柜体	体积
150	0.029
200	0.039

Iron 铁 - 195
 Stainless Steel 不锈钢 - 201/304
 Chrome 电镀 - CP
 Electrolysis 电解 - EL
 Nano Plating 纳米干镀 - NM
 Powder Coating: Dark Grey 碳灰 - TH



Pull Down Dish Draining Basket



Item No.	Material	Surface Treatment	Specification D*W*H(mm)
型号	材质	表面处理	规格
ZEB60-SS	195/201/304	CP/EL/NM/TH	565*300*590
ZEB70-SS	195/201/304	CP/EL/NM/TH	665*300*590
ZEB80-SS	195/201/304	CP/EL/NM/TH	765*300*590
ZEB90-SS	195/201/304	CP/EL/NM/TH	865*300*590

Cabinet(mm)	CBM(1SET/M3)
柜体	体积
600	0.091
700	0.108
800	0.124
900	0.141

Iron 铁 - 195
 Stainless Steel 不锈钢 - 201/304
 Chrome 电镀 - CP
 Electrolysis 电解 - EL
 Nano Plating 纳米干镀 - NM
 Powder Coating: Dark Grey 碳灰 - TH



Pull Down Simple Basket



Item No.	Material	Surface Treatment	Specification D*W*H(mm)
型号	材质	表面处理	规格
ZIT-302A-700	195	CP/NM/TH	665*280*605

Cabinet(mm)	CBM(1SET/M3)
柜体	体积
700	0.121

Iron 铁 - 195
 Stainless Steel 不锈钢 - 201/304
 Chrome 电镀 - CP
 Electrolysis 电解 - EL
 Nano Plating 纳米干镀 - NM
 Powder Coating: Dark Grey 碳灰 - TH



S.S Dish Draining Racks



Item No.	Material	Surface Treatment	Specification D*W*H(mm)
型号	材质	表面处理	规格
ZTH-1000C	201/304	CP	280*965*65
ZTH-900C	201/304	CP	280*865*65
ZTH-800C	201/304	CP	280*765*65
ZTH-700C	201/304	CP	280*665*65
ZTH-600C	201/304	CP	280*565*65
ZTH-500C	201/304	CP	280*465*65
ZTH-400C	201/304	CP	280*365*65

Cabinet(mm)	柜体	CBM(1SET/M3)	体积
1000		0.112	
900		0.102	
800		0.091	
700		0.08	
600		0.069	
500		0.058	
400		0.047	

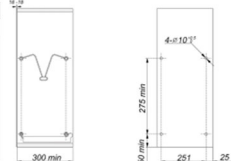

Iron 铁 - 195
 Stainless Steel 不锈钢 - 201/304
 Chrome 电镀 - CP
 Electrolysis 电解 - EL
 Nano Plating 纳米干镀 - NM
 Powder Coating: Dark Grey 碳灰 - TH

MATERIAL	PRODUCT SPECIFICATION	L	A
	D x W x H (mm)	mm	mm
SI001304	C280*V965*H65	280-368	400mm
SI001	C280*V865*H65	215-313	400mm
SI001304	C280*V765*H65	140-438	500mm
SI001304	C280*V665*H65	65-538	600mm
SI001304	C280*V565*H65	65-538	700mm
SI001304	C280*V465*H65	135-538	800mm
SI001304	C280*V365*H65	85-538	900mm
SI001304	C280*V265*H65	85-538	1000mm

Size "B" & Size "C" are based on height of cabinet. The following sizes are for your reference.
 B=275mm, C=300mm (Both sizes FYR)

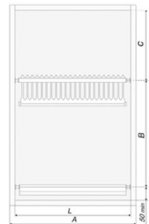

S.S. 2 Tier Dish Drying Racks



Item No.	Material	Surface Treatment
型号	材质	表面处理
ZD-1340	201/304	Stainless Steel
ZD-1345	201/304	Stainless Steel
ZD-1350	201/304	Stainless Steel
ZD-1355	201/304	Stainless Steel
ZD-1360	201/304	Stainless Steel

Specification D*W*H(mm)	规格	CBM(1SET/M3)	体积
360*270*450		0.044	
410*270*450		0.05	
460*270*450		0.056	
510*270*450		0.062	
560*270*450		0.068	

Iron 铁 - 195
 Stainless Steel 不锈钢 - 201/304
 Chrome 电镀 - CP
 Electrolysis 电解 - EL
 Nano Plating 纳米干镀 - NM
 Powder Coating: Dark Grey 碳灰 - TH



Aluminum Half-Drawing Bowl Basket



Item No.	Material & Surface Treatment	Specification D*W*H(mm)
型号	材质及表面处理	规格 (415MM/465MM)
Z101019003	铝合金 + ABS (Al + ABS)	495*415(465)*225
Z101016503	铝合金 + ABS (Al + ABS)	545*415(465)*225
Z101017003	铝合金 + ABS (Al + ABS)	595*415(465)*225
Z101017503	铝合金 + ABS (Al + ABS)	645*415(465)*225
Z101018003	铝合金 + ABS (Al + ABS)	695*415(465)*225
Z101018503	铝合金 + ABS (Al + ABS)	745*415(465)*225
Z101019003	铝合金 + ABS (Al + ABS)	795*415(465)*225

Cabinet(mm)	CBM(1SET/M3)
柜体	体积
600	0.046
650	0.051
700	0.056
750	0.061
800	0.065
850	0.07
900	0.075

This product would be customized as 650mm/720mm/850mm cabinet.

本产品可定制 650mm/720mm/850mm 柜体



Aluminum Full-Drawing Bowl Basket



Item No.	Material & Surface Treatment	Specification D*W*H(mm)
型号	材质及表面处理	规格 (415MM/465MM)
Z101019004	铝合金 + ABS (Al + ABS)	495*415(465)*225
Z101016504	铝合金 + ABS (Al + ABS)	545*415(465)*225
Z101017004	铝合金 + ABS (Al + ABS)	595*415(465)*225
Z101017504	铝合金 + ABS (Al + ABS)	645*415(465)*225
Z101018004	铝合金 + ABS (Al + ABS)	695*415(465)*225
Z101018504	铝合金 + ABS (Al + ABS)	745*415(465)*225
Z101019004	铝合金 + ABS (Al + ABS)	795*415(465)*225

Cabinet(mm)	CBM(1SET/M3)
柜体	体积
600	0.046
650	0.051
700	0.056
750	0.061
800	0.065
850	0.07
900	0.075

Iron 铁 - 195
 Stainless Steel 不锈钢 - 201/304
 Chrome 电镀 - CP
 Electrolysis 电解 - EL
 Nano Plating 纳米干镀 - NM
 Powder Coating: Dark Grey 碳灰 - TH



Aluminum Full Drawing Seasoning Basket



Item No.	Material & Surface Treatment	Specification D*W*H(mm)
型号	材质及表面处理	规格 (465MM/420MM)
Z101013001	铝合金 + ABS (Al + ABS)	240*465(420)*510
Z101013501	铝合金 + ABS (Al + ABS)	290*465(420)*510
Z101014001	铝合金 + ABS (Al + ABS)	350*465(420)*510
Z101014501	铝合金 + ABS (Al + ABS)	390*465(420)*510

Cabinet(mm)	CBM(1SET/PCS)
柜体	体积
300	0.062
350	0.062
400	0.088
450	0.098



Aluminum Side Hanging Glass Basket



Item No.	Material & Surface Treatment	Specification D*W*H(mm)
型号	材质及表面处理	规格
Z101013021	铝合金 + ABS (Al + ABS)	240*465*510
Z101013521	铝合金 + ABS (Al + ABS)	290*465*510
Z101014021	铝合金 + ABS (Al + ABS)	350*465*510
Z101014521	铝合金 + ABS (Al + ABS)	390*465*510

Cabinet(mm)	CBM(1SET/PCS)
柜体	体积
300	0.062
350	0.062
400	0.088
450	0.098



Aluminum Side Pull Out Glass Basket



Item No.	Material & Surface Treatment	Specification D*W*H(mm)
型号	材质及表面处理	规格
Z10101201	铝合金 + ABS (A1 + ABS)	140*465*510
Z10101202	铝合金 + ABS (A1 + ABS)	140*465*510
Z10101203	铝合金 + ABS (A1 + ABS)	140*465*510
Z10101202	铝合金 + ABS (A1 + ABS)	190*465*510

Cabinet(mm)	CBM(1SET/M3)
柜体	体积
200 Left	0.037
200 Right	0.037
250 Left	0.049
250 Right	0.049



Glass Basket Soft Stop Pantry Unit (Left/Right is Universal)



Item No.	Material & Surface Treatment
型号	材质及表面处理
ZLD30-1206	Glass Basket * 6 Tiers
ZLD30-1205	Glass Basket * 5 Tiers
ZLD30-1204	Glass Basket * 4 Tiers
ZLD30-906	Glass Basket * 6 Tiers
ZLD30-905	Glass Basket * 5 Tiers
ZLD30-904	Glass Basket * 4 Tiers

Specification D*W*H(mm)	Cabinet(mm)
规格	柜体
530*1100*(1920-2220)	1200
530*1100*(1620-1920)	1200
530*1100*(1320-1620)	1200
530*780*(1920-2220)	900
530*780*(1620-1920)	900
530*780*(1320-1620)	900

- Modular design, each tier height would be adjustable according to different goods.
- Max. load bearing of each layer is 10KG.
- Soft closing sildes.



Glass Basket Soft Stop Pantry Unit (Left/Right is Universal)



Item No.	Material & Surface Treatment	Specification D*W*H(mm)	Cabinet(mm)
型号	材质及表面处理	规格	柜体
ZLD30-606	Glass Basket * 6 Tiers	530*535*(1920-2220)	600
ZLD30-605	Glass Basket * 5 Tiers	530*535*(1620-1920)	600
ZLD30-604	Glass Basket * 4 Tiers	530*535*(1320-1620)	600
ZLD30-456	Glass Basket * 6 Tiers	530*385*(1920-2220)	450
ZLD30-455	Glass Basket * 5 Tiers	530*385*(1620-1920)	450
ZLD30-454	Glass Basket * 4 Tiers	530*385*(1320-1620)	450

- Modular design, each tier height would be adjustable according to different goods.
- Max. load bearing of each layer is 10KG.
- Soft closing slides.



Glass Basket Soft Stop Top Unit



Item No.	Material & Surface Treatment
型号	材质及表面处理
ZGS30-406	Glass Basket * 6 Tiers
ZGS30-405	Glass Basket * 5 Tiers
ZGS30-404	Glass Basket * 4 Tiers
ZGS30-306	Glass Basket * 6 Tiers
ZGS30-305	Glass Basket * 5 Tiers
ZGS30-304	Glass Basket * 4 Tiers
ZGS30-256	Glass Basket * 6 Tiers
ZGS30-255	Glass Basket * 5 Tiers
ZGS30-254	Glass Basket * 4 Tiers
ZGS30-206	Glass Basket * 6 Tiers
ZGS30-205	Glass Basket * 5 Tiers
ZGS30-204	Glass Basket * 4 Tiers

Specification D*W*H(mm)	Cabinet(mm)
规格	柜体
505*350*(1970-2270)	400
505*350*(1570-1970)	400
505*350*(1270-1570)	400
505*250*(1970-2270)	300
505*250*(1570-1970)	300
505*250*(1270-1570)	300
505*200*(1970-2270)	250
505*200*(1570-1970)	250
505*200*(1270-1570)	250
505*155*(1970-2270)	200
505*155*(1570-1970)	200
505*155*(1270-1570)	200

- Baskets would be movable, each tier would be adjustable according to different goods, fix baskets with stainless pins.
- Heavy duty soft closing slides, each basket of load bearing is 5kg.

Glass Basket Soft Stop Magic Corner (Left/Right Installaion is Universal)



Item No.	Material & Surface Treatment
型号	材质及表面处理
ZLD30-602	Glass Basket * 2 Tiers
ZLD30-452	Glass Basket * 2 Tiers

Specification D*W*H(mm)	Cabinet(mm)
规格	柜体
530*535*(530-860)	600
530*385*(530-860)	450

- Modular design, each tier height would be adjustable according to different goods.
- Max. load bearing of each layer is 10KG.
- Soft closing slides.



Glass Basket Soft Stop Magic Corner (Left or Right Open)



Item No.	Material & Surface Treatment
型号	材质及表面处理
ZLD30-CON-L	Glass Basket * 2 Tiers
ZLD30-CON-R	Glass Basket * 2 Tiers

Specification D*W*H(mm)	Cabinet(mm)
规格	柜体
500*860*530	900
500*860*530	900

- Modular design, each tier height would be adjustable according to different goods.
- Max. load bearing of each layer is 10KG.
- Soft closing slides.

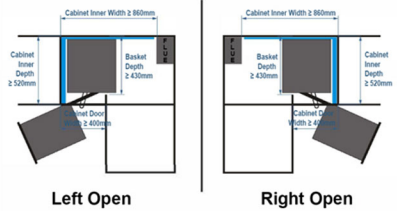

Glass Basket Soft Stop Pull Down Basket



Item No.	Material & Surface Treatment
型号	材质及表面处理
ZDG30-900	Glass Basket * 2 Tiers
ZDG30-800	Glass Basket * 2 Tiers
ZDG30-700	Glass Basket * 2 Tiers
ZDG30-600	Glass Basket * 2 Tiers

Specification D*W*H(mm)	Cabinet(mm)
规格	柜体
280*864*560	900
280*764*560	800
280*664*560	700
280*564*560	600





- The mechanical linkage system allows the basket to pull down to the most convenient position for picking up objects.
- Soft closing system, 4 levels are adjustable, which can adjust the strength according to the total weight of the placed items.
- Max. loading is 12KG.

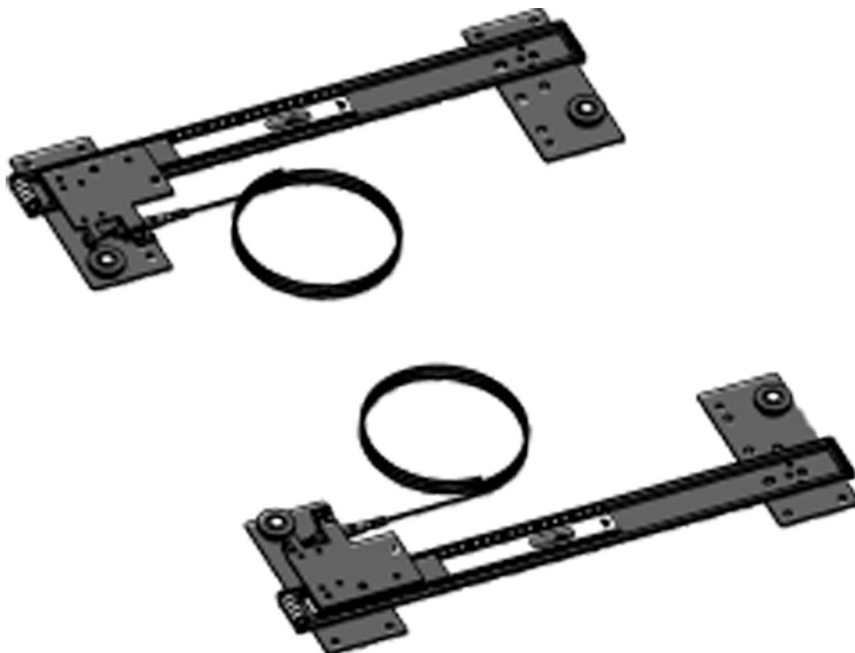

Pocket Sliding System



ITEM NO.	THICKNESS (mm)	COLOR	STANDARD FITTINGS
Z3508-337	1.5*1.5	BLACK	2 DTC HINGES PER SET, KIT BAG INCLUDES CONNECTING WIRES AND SCRES
Z3508-405	1.5*1.5	BLACK	
Z3508-437	1.5*1.5	BLACK	
Z3508-501	1.5*1.5	BLACK	
Z3508-533	1.5*1.5	BLACK	
Z3508-600	1.5*1.5	BLACK	
Z3508-650	1.5*1.5	BLACK	

- 🔑 M4x8  Board 15-18mm Middle Curve Φ 35mm
- 🔑 4,0x14  Board 15-25mm High Curve Φ 40mm
- 🔑 3,5x22  Board 15-18mm Middle Curve Φ 40mm
- 🌀 Limit Pulley  Board 15-18mm Middle Curve Φ 40mm

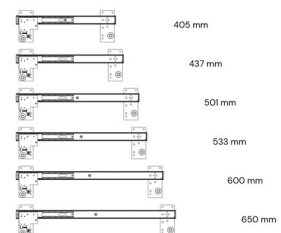

Stepper Sliding System

16"(400mm) Stepper Sliding System Diagram

Enclose

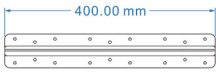

Full Extension 1

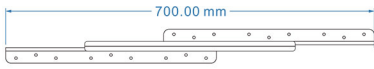

Full Extension 2

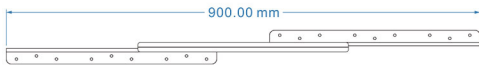

Stepper Slide Installation Structure Diagram

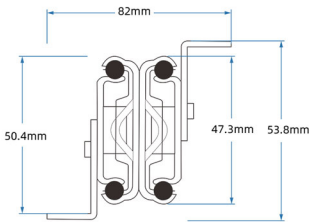

Cabinet Depth(mm)	Slide Size(inch)	Full Extension Size(mm)	Travel(mm)
400-600	16	700/900	300/500
600-800	24	1100/1450	500/850
800-1000	32	1500/1850	700/1050
1000-1200	40	1900/2250	900/1250
More than 1200	Custom Made (Max. 2000mm)	Custom Made (Max. 4000mm)	

How To Choose (Instance)

I: Make 4 Drawer, Stepper Length 1000mm
 A: Choose a 40" Short Slide (3 sets of 1900mm in full extension) and a 40" Long Slide (1 set of 2250mm in full extension)

Stepper Slide Length (MM)	Sections	Full Extension (MM)	Material Thickness (mm)	Color
400	3	700	2	Zinc Plated
400	3	900	2	Zinc Plated
600	3	1100	2	Zinc Plated
600	3	1450	2	Zinc Plated
800	3	1500	2	Zinc Plated
800	3	1850	2	Zinc Plated
1000	3	1900	2	Zinc Plated
1000	3	2250	2	Zinc Plated

Ball Bearing Slides



Gap/Side (mm)

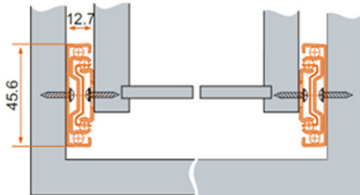

Easy Disassembly

Length: 200mm-600mm
 Max. Load: 35 Kgs
 Gap/Side: 12.7±0.2mm
 Cold rolled iron material
 Finish: Zinc Plated
 White/Black/Color

Length	1.0 Thickness Item. No.	1.2 Thickness Item. No.
长度	1.0 厚度型号	1.2 厚度型号
200mm	ZH451002-200	ZH451202-200
250mm	ZH451002-250	ZH451202-250
300mm	ZH451002-300	ZH451202-300
350mm	ZH451002-350	ZH451202-350
400mm	ZH451002-400	ZH451202-400
450mm	ZH451002-450	ZH451202-450
500mm	ZH451002-500	ZH451202-500
550mm	ZH451002-550	ZH451202-550
600mm	ZH451002-600	ZH451202-600

Drilling Diagram

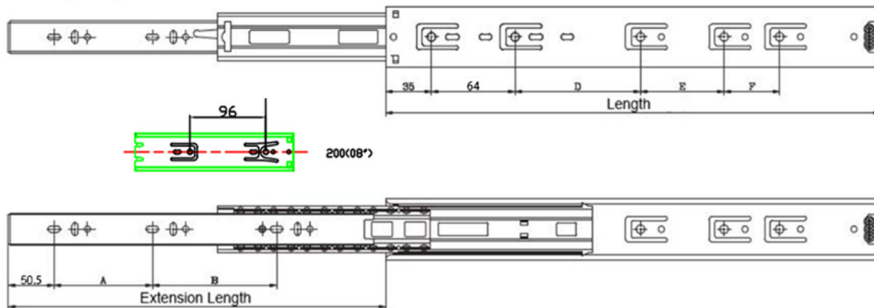

Length	Extension
长度 mm	拉出 mm
600	624
550	574
500	525
450	475
400	425
350	374
300	324
250	273
200	200

Hole Diagram 孔位及相关尺寸					
A	B	D	E	F	
224	288	160	128	128	
224	224	160	128	64	
192	224	160	128	64	
160	192	160	128		
128	192	160	64		
128	128	160			
96	128	160			
169		96			
96					

Soft Closing Ball Bearing Slides



Gap/Side (mm)

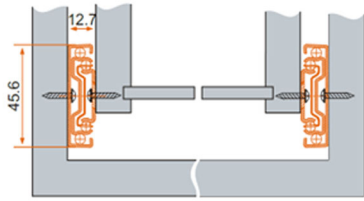

Soft Closing

Length: 250mm-600mm
 Max. Load: 35 Kgs
 Gap/Side: 12.7±0.2mm
 Cold rolled iron material
 Finish: Zinc Plated
 White/Black/Color

Length	1.0 Thickness Item. No.	1.2 Thickness Item. No.
长度	1.0 厚度型号	1.2 厚度型号
200mm	ZH451013-200	ZH451213-200
250mm	ZH451013-250	ZH451213-250
300mm	ZH451013-300	ZH451213-300
350mm	ZH451013-350	ZH451213-350
400mm	ZH451013-400	ZH451213-400
450mm	ZH451013-450	ZH451213-450
500mm	ZH451013-500	ZH451213-500
550mm	ZH451013-550	ZH451213-550
600mm	ZH451013-600	ZH451213-600

Drilling Diagram

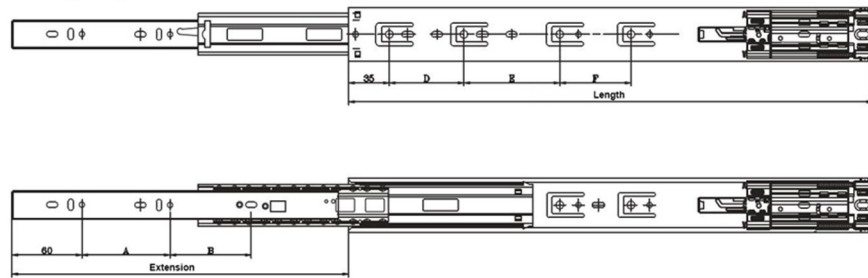

Length	Extension
长度 mm	拉出 mm
600	600
550	550
500	500
450	450
400	400
350	334
300	270
250	241
200	150

Hole Diagram 孔位及相关尺寸					
A	B	D	E	F	
224	200.1	64	160	128+101.5	
224	150.1	64	160	269.5	
192	132.1	64	160	219	
160	114.1	64	160	169	
128	96.1	64	64+215.5		
96	78.1	64	64+165		
64	60.1	64	179		
109.6		64	126		
59.6		140			

Push Open Ball Bearing Slides

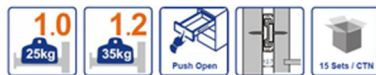

Gap/Side (mm)

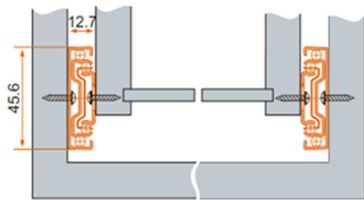

Soft Closing

Length: 250mm-600mm
 Max. Load: 35 Kgs
 Gap/Side: 12.7±0.2mm
 Cold rolled iron material
 Finish: Zinc Plated
 White/Black/Color

Length	1.0 Thickness Item. No.	1.2 Thickness Item. No.
长度	1.0 厚度型号	1.2 厚度型号
250mm	ZH451021-250	ZH451221-250
300mm	ZH451021-300	ZH451221-300
350mm	ZH451021-350	ZH451221-350
400mm	ZH451021-400	ZH451221-400
450mm	ZH451021-450	ZH451221-450
500mm	ZH451021-500	ZH451221-500
550mm	ZH451021-550	ZH451221-550
600mm	ZH451021-600	ZH451221-600

Drilling Diagram

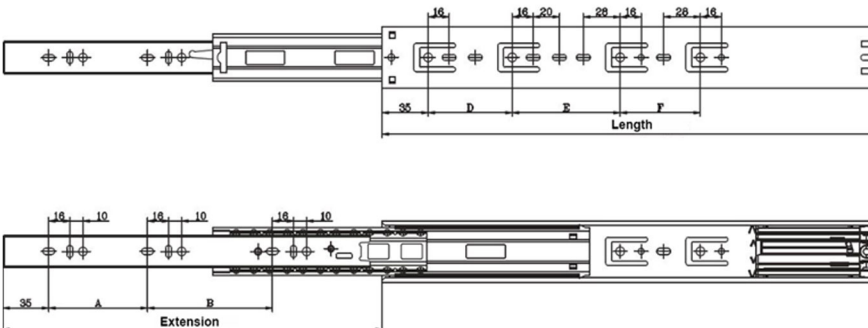

Length	Extension
长度 mm	拉出 mm
600	600
550	550
500	500
450	450
400	400
350	350
300	293
250	250

Hole Diagram 孔位及相关尺寸						
A	B	D	E	F	Hole Number	Ball Bearing Part Length
224	256	64	160	160	9	236
224	224	64	160		8	212
160	224	64	160		7	190
160	192	64	160		6	161
128	160	64	160		5	141
128	128	64	128		4	100
192		64	96		4	89
160		64			3	50

Push Open Soft Closing Ball Bearing Slides

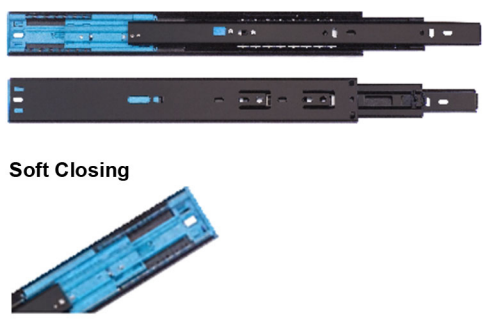
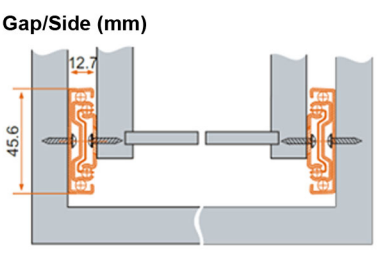

Length	1.0 Thickness Item. No.	1.2 Thickness Item. No.
长度	1.0 厚度型号	1.2 厚度型号
350mm	ZH451031-350	ZH451231-350
400mm	ZH451031-400	ZH451231-400
450mm	ZH451031-450	ZH451231-450
500mm	ZH451031-500	ZH451231-500
550mm	ZH451031-550	ZH451231-550
600mm	ZH451031-600	ZH451231-600

Drilling Diagram

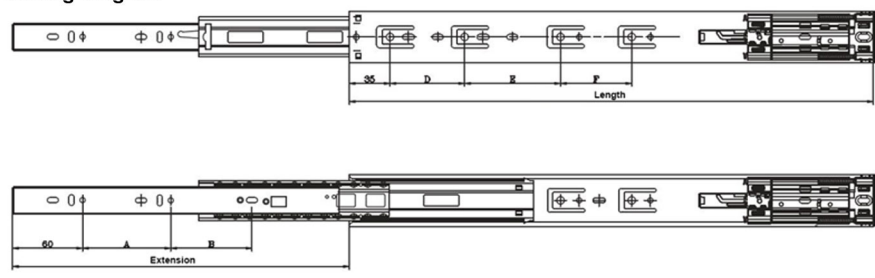

Length	Extension
长度 mm	拉出 mm
600	608
550	558
500	508
450	458
400	403
350	338

Hole Diagram 孔位及相关尺寸						
A	B	D	E	F	Hole Number	Ball Beating Part Length
224	256	64	160	160	9	236
224	224	64	160		8	195
160	224	64	160		7	175
160	192	64	160		6	140
128	160	64	160		5	105
96	81	64	128		4	70

Single Extension Soft Closing Concealed Drawer Slides (With Adjustable Pins)



Length: 250mm-600mm
 Max. Load: 25 Kgs
 Single Extension
 Finish: Zinc Plated White/Black
 Detachable Drawer
 Silent and Smooth
 Drawer height would be adjusted: 0 ~ +4 mm
 Base Mounted / Screw Fixing



Length	16mm Board Item. No.	19mm Board Item. No.
长度	16mm板	19mm板
250mm	ZR882TH-16-250	ZR882TH-19-250
300mm	ZR882TH-16-300	ZR882TH-19-300
350mm	ZR882TH-16-350	ZR882TH-19-350
400mm	ZR882TH-16-400	ZR882TH-19-400
450mm	ZR882TH-16-450	ZR882TH-19-450
500mm	ZR882TH-16-500	ZR882TH-19-500
550mm	ZR882TH-16-550	ZR882TH-19-550
600mm	ZR882TH-16-600	ZR882TH-19-600

Slide Installation Diagram

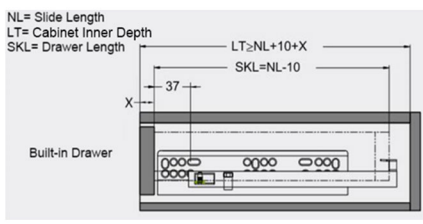
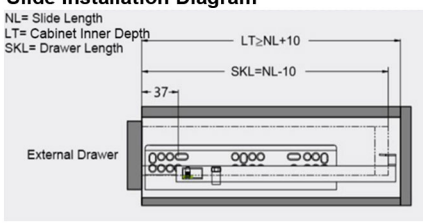

Slide Installation Diagram

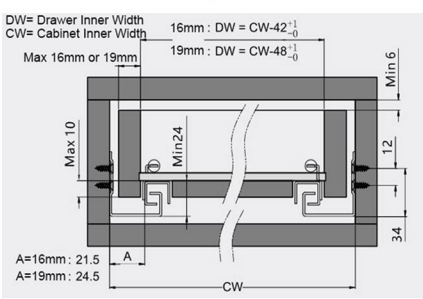

Drawer Installation Diagram

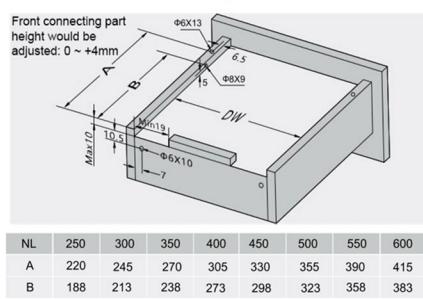

Drilling Diagram

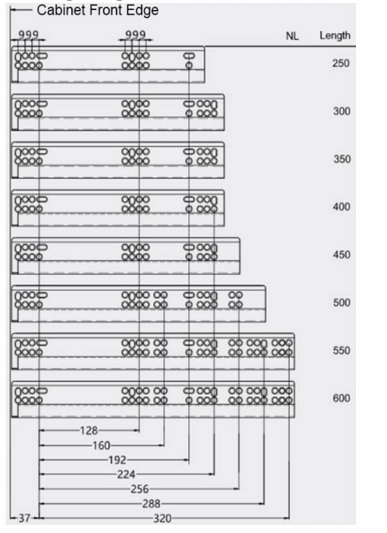

Single Extension Soft Closing Push Open Concealed Drawer Slides (Adjustable Pins)



Length: 250mm-600mm
 Max. Load: 25 Kgs
 Single Extension
 Finish: Zinc Plated White/Black
 Detachable Drawer
 Silent and Smooth
 Drawer height would be adjusted: 0 ~ +4 mm
 Base Mounted / Screw Fixing



Length	16mm Board Item. No.	19mm Board Item. No.
长度	16mm板	19mm板
250mm	ZR882TP-16-250	ZR882TP-19-250
300mm	ZR882TP-16-300	ZR882TP-19-300
350mm	ZR882TP-16-350	ZR882TP-19-350
400mm	ZR882TP-16-400	ZR882TP-19-400
450mm	ZR882TP-16-450	ZR882TP-19-450
500mm	ZR882TP-16-500	ZR882TP-19-500
550mm	ZR882TP-16-550	ZR882TP-19-550
600mm	ZR882TP-16-600	ZR882TP-19-600

Slide Installation Diagram

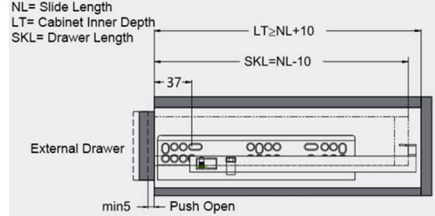

Soft Closing

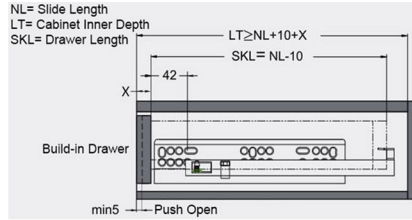

Drilling Diagram

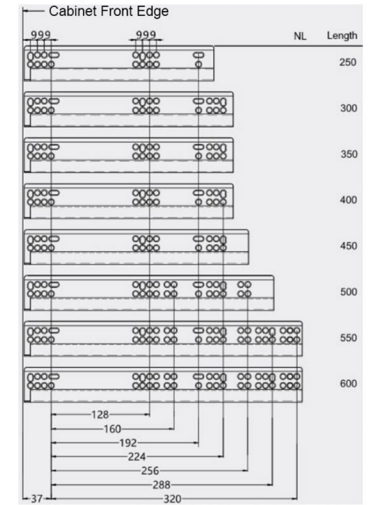

Slide Installation Diagram

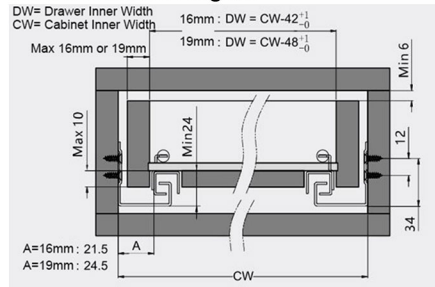

Slide Installation Diagram

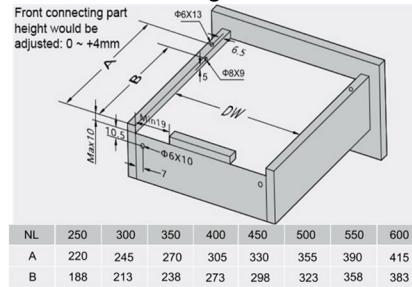

Single Extension Soft Closing Concealed Drawer Slides (With Handles)



Length: 250mm-600mm
 Max. Load: 25 Kgs
 Single Extension
 Finish: Zinc Plated White/Black
 Detachable Drawer
 Silent and Smooth
 Drawer height would be adjusted: 0 ~ +4 mm
 Base Mounted / Screw Fixing



Length	16mm Board Item. No.	19mm Board Item. No.
长度	16mm板	19mm板
250mm	ZR882JH-16-250	ZR882JH-19-250
300mm	ZR882JH-16-300	ZR882JH-19-300
350mm	ZR882JH-16-350	ZR882JH-19-350
400mm	ZR882JH-16-400	ZR882JH-19-400
450mm	ZR882JH-16-450	ZR882JH-19-450
500mm	ZR882JH-16-500	ZR882JH-19-500
550mm	ZR882JH-16-550	ZR882JH-19-550
600mm	ZR882JH-16-600	ZR882JH-19-600

Slide Installation Diagram

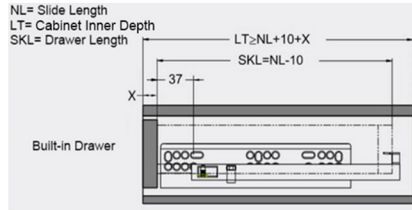
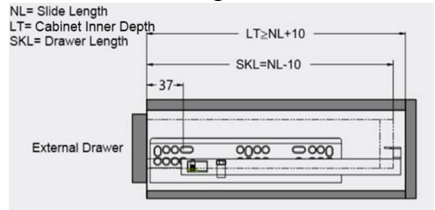

Drilling Diagram

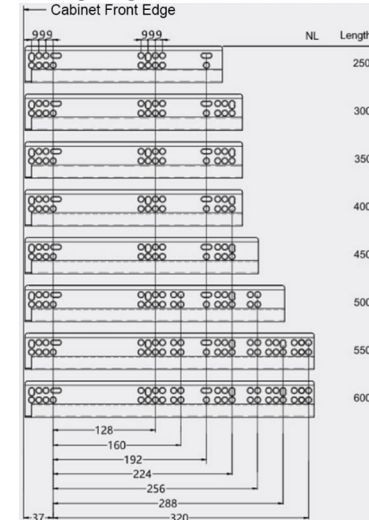

Slide Installation Diagram

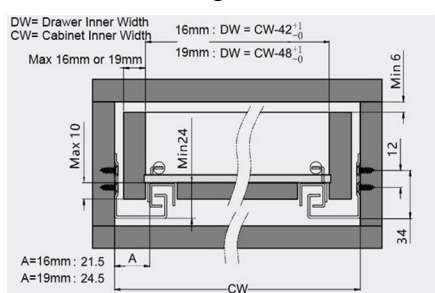

Drawer Installation Diagram

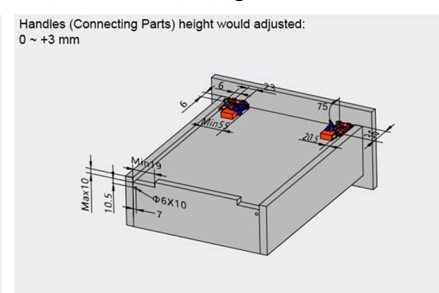

Single Extension Soft Closing Concealed Drawer Slides (With Handles)



Length: 250mm-600mm
 Max. Load: 25 Kgs
 Single Extension
 Finish: Zinc Plated White/Black
 Detachable Drawer
 Silent and Smooth
 Drawer height would be adjusted: 0 ~ + 3 mm
 Base Mounted / Screw Fixing

Length	16mm Board Item. No.	19mm Board Item. No.
250mm	ZR882JP-16-250	ZR882JP-19-250
300mm	ZR882JP-16-300	ZR882JP-19-300
350mm	ZR882JP-16-350	ZR882JP-19-350
400mm	ZR882JP-16-400	ZR882JP-19-400
450mm	ZR882JP-16-450	ZR882JP-19-450
500mm	ZR882JP-16-500	ZR882JP-19-500
550mm	ZR882JP-16-550	ZR882JP-19-550
600mm	ZR882JP-16-600	ZR882JP-19-600

Slide Installation Diagram

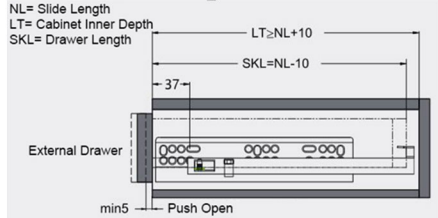

Soft Closing

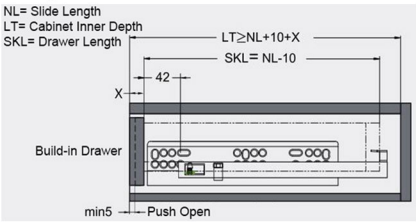

Drilling Diagram

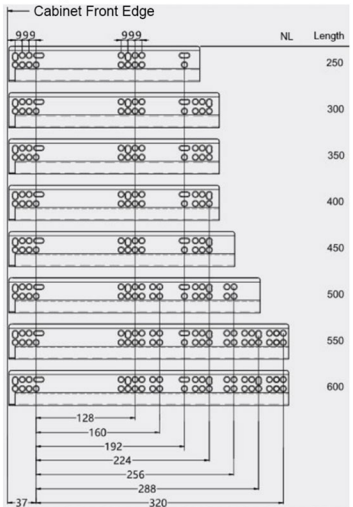

Slide Installation Diagram

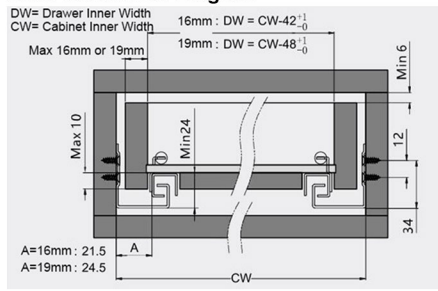

Slide Installation Diagram

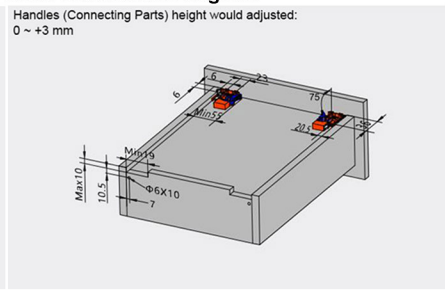

Full Extension Soft Closing Concealed Drawer Slides (With Adjustable Pins)



Length: 250mm-600mm
 Max. Load: 35 Kgs
 Full Extension
 Finish: Zinc Plated White/Black
 Detachable Drawer
 Silent and Smooth
 Drawer height would be adjusted: 0 ~ + 4 mm
 Base Mounted / Screw Fixing

Length	16mm Board Item. No.	19mm Board Item. No.
250mm	ZR883TH-16-250	ZR883TH-19-250
300mm	ZR883TH-16-300	ZR883TH-19-300
350mm	ZR883TH-16-350	ZR883TH-19-350
400mm	ZR883TH-16-400	ZR883TH-19-400
450mm	ZR883TH-16-450	ZR883TH-19-450
500mm	ZR883TH-16-500	ZR883TH-19-500
550mm	ZR883TH-16-550	ZR883TH-19-550
600mm	ZR883TH-16-600	ZR883TH-19-600

Slide Installation Diagram

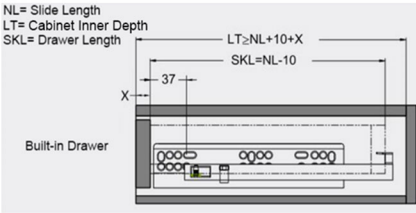
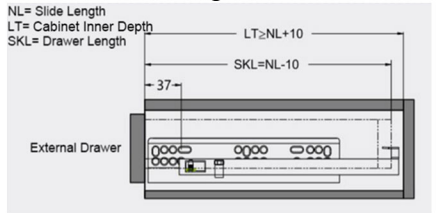

Drilling Diagram

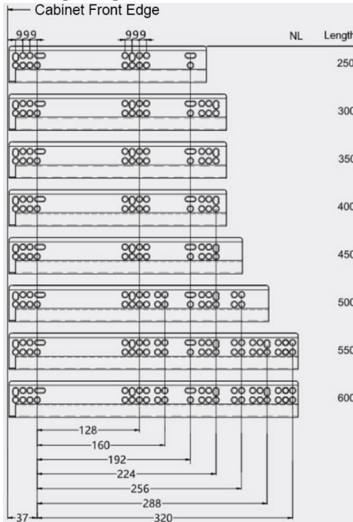

Slide Installation Diagram

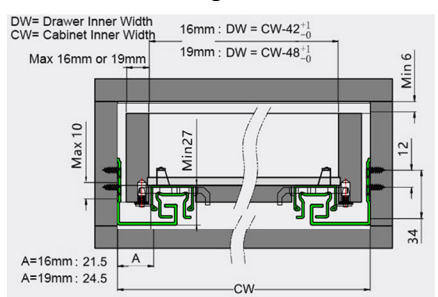

Drawer Installation Diagram

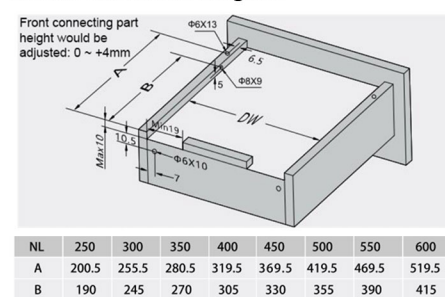

Full Extension Soft Closing Push Open Concealed Drawer Slides(Adjustable Pins)



Length: 250mm-600mm
 Max. Load: 35 Kgs
 Full Extension
 Finish: Zinc Plated White/Black
 Detachable Drawer
 Silent and Smooth
 Drawer height would be adjusted: 0 ~ + 4 mm
 Base Mounted / Screw Fixing



Length	16mm Board Item. No.	19mm Board Item. No.
250mm	ZR883TP-16-250	ZR883TP-19-250
300mm	ZR883TP-16-300	ZR883TP-19-300
350mm	ZR883TP-16-350	ZR883TP-19-350
400mm	ZR883TP-16-400	ZR883TP-19-400
450mm	ZR883TP-16-450	ZR883TP-19-450
500mm	ZR883TP-16-500	ZR883TP-19-500
550mm	ZR883TP-16-550	ZR883TP-19-550
600mm	ZR883TP-16-600	ZR883TP-19-600

Slide Installation Diagram

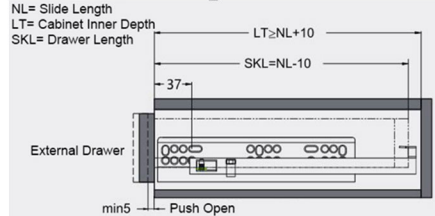

Soft Closing

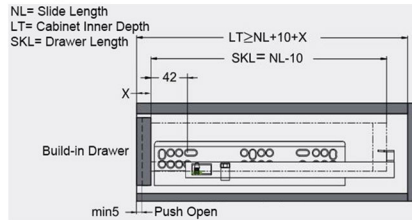

Slide Installation Diagram

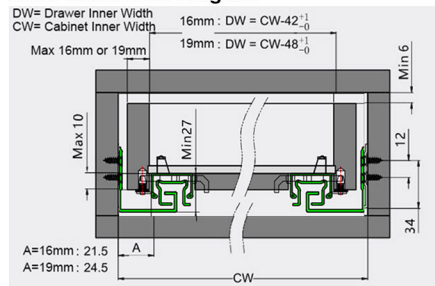

Slide Installation Diagram

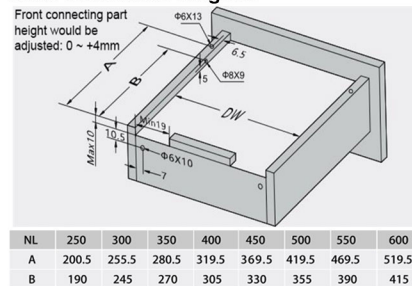

Drilling Diagram

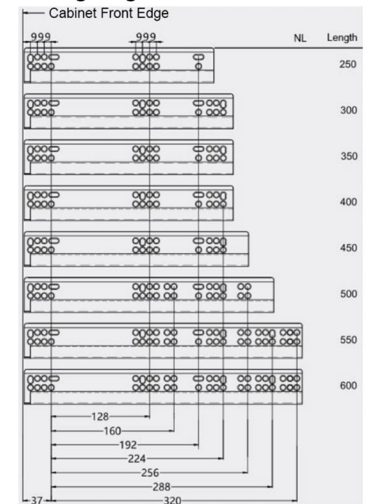

Full Extension Soft Closing Concealed Drawer Slides (With Handles)



Length: 250mm-600mm
 Max. Load: 35 Kgs
 Full Extension
 Finish: Zinc Plated White/Black
 Detachable Drawer
 Silent and Smooth
 Drawer height would be adjusted: 0 ~ + 3 mm
 Base Mounted / Screw Fixing



Length	16mm Board Item. No.	19mm Board Item. No.
250mm	ZR883JH-16-250	ZR883JH-19-250
300mm	ZR883JH-16-300	ZR883JH-19-300
350mm	ZR883JH-16-350	ZR883JH-19-350
400mm	ZR883JH-16-400	ZR883JH-19-400
450mm	ZR883JH-16-450	ZR883JH-19-450
500mm	ZR883JH-16-500	ZR883JH-19-500
550mm	ZR883JH-16-550	ZR883JH-19-550
600mm	ZR883JH-16-600	ZR883JH-19-600

Slide Installation Diagram

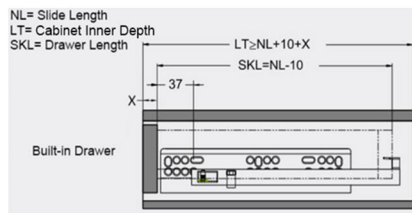
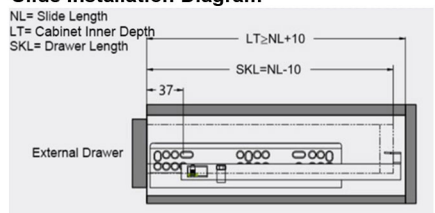

Slide Installation Diagram

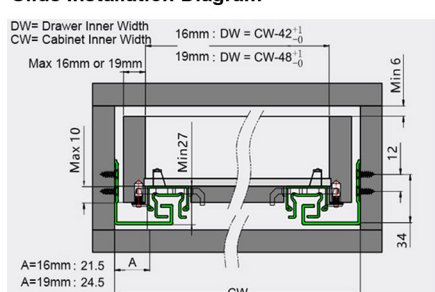

Drawer Installation Diagram

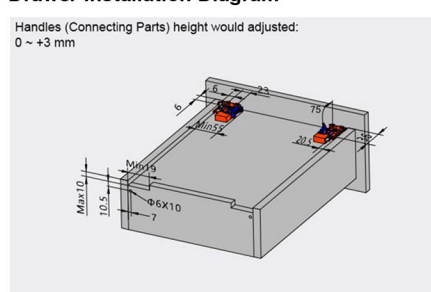

Drilling Diagram

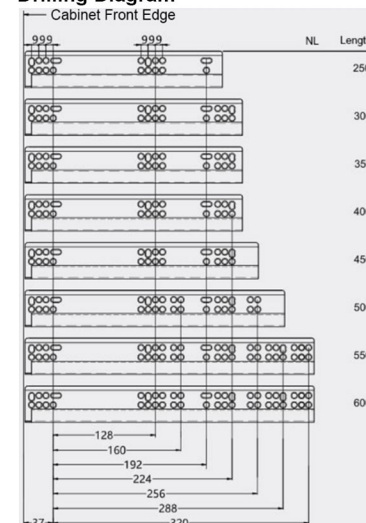

Full Extension Soft Closing Push Open Concealed Drawer Slides (With Handles)



Length: 250mm-600mm
 Max. Load: 35 Kgs
 Full Extension
 Finish: Zinc Plated White/Black
 Detachable Drawer
 Silent and Smooth
 Drawer height would be adjusted: 0 ~ + 3 mm
 Base Mounted / Screw Fixing



Length	16mm Board Item. No.	19mm Board Item. No.
长度	16mm板	19mm板
250mm	ZR883JP-16-250	ZR883JP-19-250
300mm	ZR883JP-16-300	ZR883JP-19-300
350mm	ZR883JP-16-350	ZR883JP-19-350
400mm	ZR883JP-16-400	ZR883JP-19-400
450mm	ZR883JP-16-450	ZR883JP-19-450
500mm	ZR883JP-16-500	ZR883JP-19-500
550mm	ZR883JP-16-550	ZR883JP-19-550
600mm	ZR883JP-16-600	ZR883JP-19-600

Slide Installation Diagram

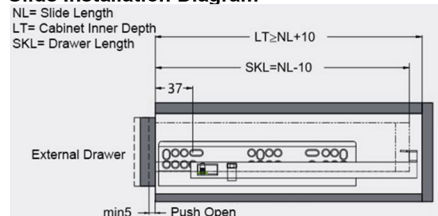

Soft Closing

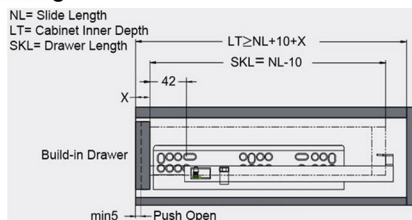

Drilling Diagram

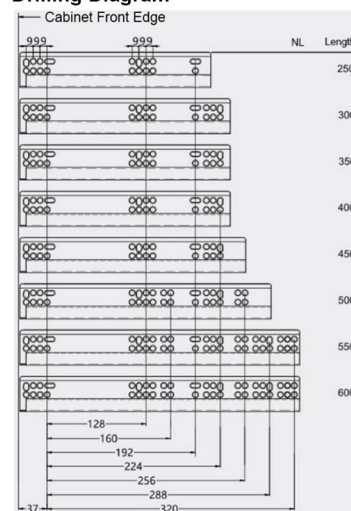

Slide Installation Diagram

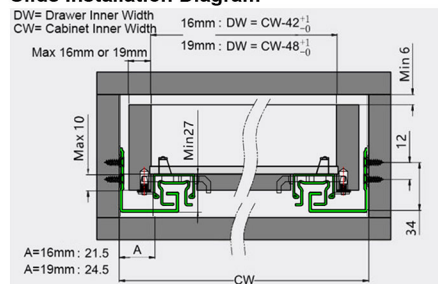

Slide Installation Diagram

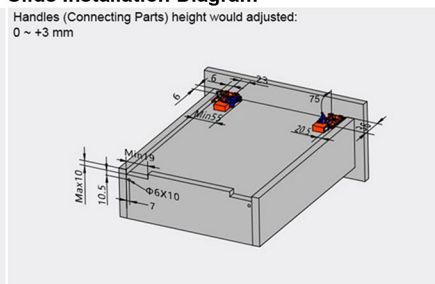

Two Way Soft Closing Fixing Hinge



ZHE01A (Full Overlay)																															
		<table border="1"> <tr> <td rowspan="2">H mm</td> <td colspan="5">K mm</td> </tr> <tr> <td>3</td> <td>4</td> <td>5</td> <td>6</td> <td>7</td> </tr> <tr> <td>0</td> <td>18</td> <td>19</td> <td>20</td> <td>21</td> <td>22</td> </tr> <tr> <td>2</td> <td>16</td> <td>17</td> <td>18</td> <td>19</td> <td>20</td> </tr> <tr> <td colspan="6">H=14+K-D</td> </tr> </table>	H mm	K mm					3	4	5	6	7	0	18	19	20	21	22	2	16	17	18	19	20	H=14+K-D					
H mm	K mm																														
	3	4	5	6	7																										
0	18	19	20	21	22																										
2	16	17	18	19	20																										
H=14+K-D																															
ZHE01B (Half Overlay)																															
		<table border="1"> <tr> <td rowspan="2">H mm</td> <td colspan="5">K mm</td> </tr> <tr> <td>3</td> <td>4</td> <td>5</td> <td>6</td> <td>7</td> </tr> <tr> <td>0</td> <td>9</td> <td>10</td> <td>11</td> <td>12</td> <td>13</td> </tr> <tr> <td>2</td> <td>7</td> <td>8</td> <td>9</td> <td>10</td> <td>11</td> </tr> <tr> <td colspan="6">H=5+K-D</td> </tr> </table>	H mm	K mm					3	4	5	6	7	0	9	10	11	12	13	2	7	8	9	10	11	H=5+K-D					
H mm	K mm																														
	3	4	5	6	7																										
0	9	10	11	12	13																										
2	7	8	9	10	11																										
H=5+K-D																															
ZHE01C (Insert)																															
		<table border="1"> <tr> <td rowspan="2">H mm</td> <td colspan="5">K mm</td> </tr> <tr> <td>3</td> <td>4</td> <td>5</td> <td>6</td> <td>7</td> </tr> <tr> <td>0</td> <td>-2</td> <td>-3</td> <td>-4</td> <td>-5</td> <td>-6</td> </tr> <tr> <td>2</td> <td>0</td> <td>-1</td> <td>-2</td> <td>-3</td> <td>-4</td> </tr> <tr> <td colspan="6">H=-2+K-A</td> </tr> </table>	H mm	K mm					3	4	5	6	7	0	-2	-3	-4	-5	-6	2	0	-1	-2	-3	-4	H=-2+K-A					
H mm	K mm																														
	3	4	5	6	7																										
0	-2	-3	-4	-5	-6																										
2	0	-1	-2	-3	-4																										
H=-2+K-A																															



Opening Angle: 105°
Door Thickness: 14-21 mm
Distance to door edge (K): 3-7 mm
Depth of hinge cup: 11.3 mm
Diameter of hinge cup: 35 mm
Distance of two hole center: 48 mm

Installation Diagram

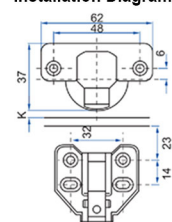

Two Way Soft Closing Clip-on Hinge



ZHE11A (Full Overlay)																									
		<table border="1"> <thead> <tr> <th rowspan="2">H mm</th> <th colspan="5">K mm</th> </tr> <tr> <th>3</th> <th>4</th> <th>5</th> <th>6</th> <th>7</th> </tr> </thead> <tbody> <tr> <td>0</td> <td>17</td> <td>18</td> <td>19</td> <td>20</td> <td>21</td> </tr> <tr> <td>2</td> <td>15</td> <td>16</td> <td>17</td> <td>18</td> <td>19</td> </tr> </tbody> </table> <p>$H=14+K-D$</p>	H mm	K mm					3	4	5	6	7	0	17	18	19	20	21	2	15	16	17	18	19
H mm	K mm																								
	3	4	5	6	7																				
0	17	18	19	20	21																				
2	15	16	17	18	19																				
ZHE11B (Half Overlay)																									
		<table border="1"> <thead> <tr> <th rowspan="2">H mm</th> <th colspan="5">K mm</th> </tr> <tr> <th>3</th> <th>4</th> <th>5</th> <th>6</th> <th>7</th> </tr> </thead> <tbody> <tr> <td>0</td> <td>8</td> <td>9</td> <td>10</td> <td>11</td> <td>12</td> </tr> <tr> <td>2</td> <td>6</td> <td>7</td> <td>8</td> <td>9</td> <td>10</td> </tr> </tbody> </table> <p>$H=5+K-D$</p>	H mm	K mm					3	4	5	6	7	0	8	9	10	11	12	2	6	7	8	9	10
H mm	K mm																								
	3	4	5	6	7																				
0	8	9	10	11	12																				
2	6	7	8	9	10																				
ZHE11C (Insert)																									
		<table border="1"> <thead> <tr> <th rowspan="2">H mm</th> <th colspan="5">K mm</th> </tr> <tr> <th>3</th> <th>4</th> <th>5</th> <th>6</th> <th>7</th> </tr> </thead> <tbody> <tr> <td>0</td> <td>-1</td> <td>-2</td> <td>-3</td> <td>-4</td> <td>-5</td> </tr> <tr> <td>2</td> <td>1</td> <td>0</td> <td>-1</td> <td>-2</td> <td>-3</td> </tr> </tbody> </table> <p>$H=-2+K-A$</p>	H mm	K mm					3	4	5	6	7	0	-1	-2	-3	-4	-5	2	1	0	-1	-2	-3
H mm	K mm																								
	3	4	5	6	7																				
0	-1	-2	-3	-4	-5																				
2	1	0	-1	-2	-3																				



Opening Angle: 105°
Door Thickness: 14-21 mm
Distance to door edge (K): 3-7 mm
Depth of hinge cup: 11.3 mm
Diameter of hinge cup: 35 mm
Distance of two hole center: 48 mm

Installation Diagram

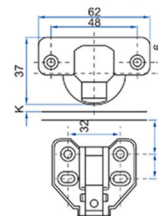

One Way Soft Closing Fixing Hinge

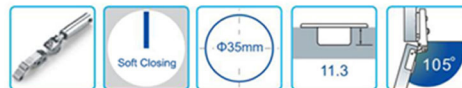

ZKA01A (Full Overlay)																									
		<table border="1"> <thead> <tr> <th rowspan="2">H mm</th> <th colspan="5">K mm</th> </tr> <tr> <th>3</th> <th>4</th> <th>5</th> <th>6</th> <th>7</th> </tr> </thead> <tbody> <tr> <td>0</td> <td>18</td> <td>19</td> <td>20</td> <td>21</td> <td>22</td> </tr> <tr> <td>2</td> <td>16</td> <td>17</td> <td>18</td> <td>19</td> <td>20</td> </tr> </tbody> </table> <p>$H=14+K-D$</p>	H mm	K mm					3	4	5	6	7	0	18	19	20	21	22	2	16	17	18	19	20
H mm	K mm																								
	3	4	5	6	7																				
0	18	19	20	21	22																				
2	16	17	18	19	20																				
ZKA01B (Half Overlay)																									
		<table border="1"> <thead> <tr> <th rowspan="2">H mm</th> <th colspan="5">K mm</th> </tr> <tr> <th>3</th> <th>4</th> <th>5</th> <th>6</th> <th>7</th> </tr> </thead> <tbody> <tr> <td>0</td> <td>9</td> <td>10</td> <td>11</td> <td>12</td> <td>13</td> </tr> <tr> <td>2</td> <td>7</td> <td>8</td> <td>9</td> <td>10</td> <td>11</td> </tr> </tbody> </table> <p>$H=5+K-D$</p>	H mm	K mm					3	4	5	6	7	0	9	10	11	12	13	2	7	8	9	10	11
H mm	K mm																								
	3	4	5	6	7																				
0	9	10	11	12	13																				
2	7	8	9	10	11																				
ZKA01C (Insert)																									
		<table border="1"> <thead> <tr> <th rowspan="2">H mm</th> <th colspan="5">K mm</th> </tr> <tr> <th>3</th> <th>4</th> <th>5</th> <th>6</th> <th>7</th> </tr> </thead> <tbody> <tr> <td>0</td> <td>-2</td> <td>-3</td> <td>-4</td> <td>-5</td> <td>-6</td> </tr> <tr> <td>2</td> <td>0</td> <td>-1</td> <td>-2</td> <td>-3</td> <td>-4</td> </tr> </tbody> </table> <p>$H=-2+K-A$</p>	H mm	K mm					3	4	5	6	7	0	-2	-3	-4	-5	-6	2	0	-1	-2	-3	-4
H mm	K mm																								
	3	4	5	6	7																				
0	-2	-3	-4	-5	-6																				
2	0	-1	-2	-3	-4																				



Opening Angle: 105°
Door Thickness: 14-21 mm
Distance to door edge (K): 3-7 mm
Depth of hinge cup: 11.3 mm
Diameter of hinge cup: 35 mm
Distance of two hole center: 48 mm

Installation Diagram

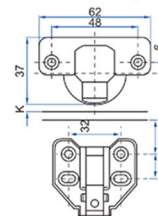

One Way Soft Closing Clip-on Hinge



ZKA11A (Full Overlay)																									
		<table border="1"> <thead> <tr> <th rowspan="2">H mm</th> <th colspan="5">K mm</th> </tr> <tr> <th>3</th> <th>4</th> <th>5</th> <th>6</th> <th>7</th> </tr> </thead> <tbody> <tr> <td>0</td> <td>17</td> <td>18</td> <td>19</td> <td>20</td> <td>21</td> </tr> <tr> <td>2</td> <td>15</td> <td>16</td> <td>17</td> <td>18</td> <td>19</td> </tr> </tbody> </table> <p style="text-align: center;">$H=14+K-D$</p>	H mm	K mm					3	4	5	6	7	0	17	18	19	20	21	2	15	16	17	18	19
H mm	K mm																								
	3	4	5	6	7																				
0	17	18	19	20	21																				
2	15	16	17	18	19																				
ZKA11B (Half Overlay)																									
		<table border="1"> <thead> <tr> <th rowspan="2">H mm</th> <th colspan="5">K mm</th> </tr> <tr> <th>3</th> <th>4</th> <th>5</th> <th>6</th> <th>7</th> </tr> </thead> <tbody> <tr> <td>0</td> <td>8</td> <td>9</td> <td>10</td> <td>11</td> <td>12</td> </tr> <tr> <td>2</td> <td>6</td> <td>7</td> <td>8</td> <td>9</td> <td>10</td> </tr> </tbody> </table> <p style="text-align: center;">$H=5+K-D$</p>	H mm	K mm					3	4	5	6	7	0	8	9	10	11	12	2	6	7	8	9	10
H mm	K mm																								
	3	4	5	6	7																				
0	8	9	10	11	12																				
2	6	7	8	9	10																				
ZKA11C (Insert)																									
		<table border="1"> <thead> <tr> <th rowspan="2">H mm</th> <th colspan="5">K mm</th> </tr> <tr> <th>3</th> <th>4</th> <th>5</th> <th>6</th> <th>7</th> </tr> </thead> <tbody> <tr> <td>0</td> <td>-1</td> <td>-2</td> <td>-3</td> <td>-4</td> <td>-5</td> </tr> <tr> <td>2</td> <td>1</td> <td>0</td> <td>-1</td> <td>-2</td> <td>-3</td> </tr> </tbody> </table> <p style="text-align: center;">$H=-2+K-A$</p>	H mm	K mm					3	4	5	6	7	0	-1	-2	-3	-4	-5	2	1	0	-1	-2	-3
H mm	K mm																								
	3	4	5	6	7																				
0	-1	-2	-3	-4	-5																				
2	1	0	-1	-2	-3																				



Opening Angle: 105°
Door Thickness: 14-21 mm
Distance to door edge (K): 3-7 mm
Depth of hinge cup: 11.3 mm
Diameter of hinge cup: 35 mm
Distance of two hole center: 48 mm

Installation Diagram

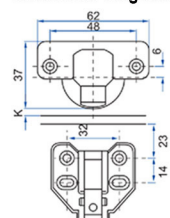

One Way Soft Closing Clip-on Hinge (2D Adjustment)



ZKA13A (Full Overlay)																									
		<table border="1"> <thead> <tr> <th rowspan="2">H mm</th> <th colspan="5">K mm</th> </tr> <tr> <th>3</th> <th>4</th> <th>5</th> <th>6</th> <th>7</th> </tr> </thead> <tbody> <tr> <td>0</td> <td>17</td> <td>18</td> <td>19</td> <td>20</td> <td>21</td> </tr> <tr> <td>2</td> <td>15</td> <td>16</td> <td>17</td> <td>18</td> <td>19</td> </tr> </tbody> </table> <p style="text-align: center;">$H=14+K-D$</p>	H mm	K mm					3	4	5	6	7	0	17	18	19	20	21	2	15	16	17	18	19
H mm	K mm																								
	3	4	5	6	7																				
0	17	18	19	20	21																				
2	15	16	17	18	19																				
ZKA13B (Half Overlay)																									
		<table border="1"> <thead> <tr> <th rowspan="2">H mm</th> <th colspan="5">K mm</th> </tr> <tr> <th>3</th> <th>4</th> <th>5</th> <th>6</th> <th>7</th> </tr> </thead> <tbody> <tr> <td>0</td> <td>8</td> <td>9</td> <td>10</td> <td>11</td> <td>12</td> </tr> <tr> <td>2</td> <td>6</td> <td>7</td> <td>8</td> <td>9</td> <td>10</td> </tr> </tbody> </table> <p style="text-align: center;">$H=5+K-D$</p>	H mm	K mm					3	4	5	6	7	0	8	9	10	11	12	2	6	7	8	9	10
H mm	K mm																								
	3	4	5	6	7																				
0	8	9	10	11	12																				
2	6	7	8	9	10																				
ZKA13C (Insert)																									
		<table border="1"> <thead> <tr> <th rowspan="2">H mm</th> <th colspan="5">K mm</th> </tr> <tr> <th>3</th> <th>4</th> <th>5</th> <th>6</th> <th>7</th> </tr> </thead> <tbody> <tr> <td>0</td> <td>-1</td> <td>-2</td> <td>-3</td> <td>-4</td> <td>-5</td> </tr> <tr> <td>2</td> <td>1</td> <td>0</td> <td>-1</td> <td>-2</td> <td>-3</td> </tr> </tbody> </table> <p style="text-align: center;">$H=-2+K-A$</p>	H mm	K mm					3	4	5	6	7	0	-1	-2	-3	-4	-5	2	1	0	-1	-2	-3
H mm	K mm																								
	3	4	5	6	7																				
0	-1	-2	-3	-4	-5																				
2	1	0	-1	-2	-3																				



Opening Angle: 105°
Door Thickness: 14-21 mm
Distance to door edge (K): 3-7 mm
Depth of hinge cup: 11.3 mm
Diameter of hinge cup: 35 mm
Distance of two hole center: 48 mm

Installation Diagram

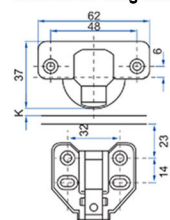

One Way Soft Closing Clip-on Hinge(3D Adjustment)



ZKA23A (Full Overlay)																									
		<table border="1"> <thead> <tr> <th rowspan="2">H mm</th> <th colspan="5">K mm</th> </tr> <tr> <th>3</th> <th>4</th> <th>5</th> <th>6</th> <th>7</th> </tr> </thead> <tbody> <tr> <td>0</td> <td>17</td> <td>18</td> <td>19</td> <td>20</td> <td>21</td> </tr> <tr> <td>2</td> <td>15</td> <td>16</td> <td>17</td> <td>18</td> <td>19</td> </tr> </tbody> </table> <p style="text-align: center;">$H=14+K-D$</p>	H mm	K mm					3	4	5	6	7	0	17	18	19	20	21	2	15	16	17	18	19
H mm	K mm																								
	3	4	5	6	7																				
0	17	18	19	20	21																				
2	15	16	17	18	19																				
ZKA23B (Half Overlay)																									
		<table border="1"> <thead> <tr> <th rowspan="2">H mm</th> <th colspan="5">K mm</th> </tr> <tr> <th>3</th> <th>4</th> <th>5</th> <th>6</th> <th>7</th> </tr> </thead> <tbody> <tr> <td>0</td> <td>8</td> <td>9</td> <td>10</td> <td>11</td> <td>12</td> </tr> <tr> <td>2</td> <td>6</td> <td>7</td> <td>8</td> <td>9</td> <td>10</td> </tr> </tbody> </table> <p style="text-align: center;">$H=5+K-D$</p>	H mm	K mm					3	4	5	6	7	0	8	9	10	11	12	2	6	7	8	9	10
H mm	K mm																								
	3	4	5	6	7																				
0	8	9	10	11	12																				
2	6	7	8	9	10																				
ZKA23C (Insert)																									
		<table border="1"> <thead> <tr> <th rowspan="2">H mm</th> <th colspan="5">K mm</th> </tr> <tr> <th>3</th> <th>4</th> <th>5</th> <th>6</th> <th>7</th> </tr> </thead> <tbody> <tr> <td>0</td> <td>-1</td> <td>-2</td> <td>-3</td> <td>-4</td> <td>-5</td> </tr> <tr> <td>2</td> <td>1</td> <td>0</td> <td>-1</td> <td>-2</td> <td>-3</td> </tr> </tbody> </table> <p style="text-align: center;">$H=-2+K-A$</p>	H mm	K mm					3	4	5	6	7	0	-1	-2	-3	-4	-5	2	1	0	-1	-2	-3
H mm	K mm																								
	3	4	5	6	7																				
0	-1	-2	-3	-4	-5																				
2	1	0	-1	-2	-3																				



Opening Angle: 105°
Door Thickness: 14-21 mm
Distance to door edge (K): 3-7 mm
Depth of hinge cup: 11.3 mm
Diameter of hinge cup: 35 mm
Distance of two hole center: 48 mm

Installation Diagram

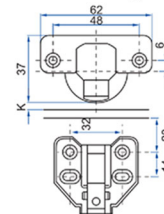

One Way Soft Closing Fixing Hinge (Al. Door)

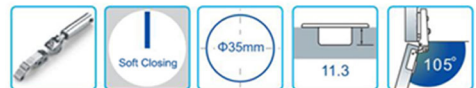

ZKA02A (Full Overlay)																									
		<table border="1"> <thead> <tr> <th rowspan="2">H mm</th> <th colspan="5">K mm</th> </tr> <tr> <th>3</th> <th>4</th> <th>5</th> <th>6</th> <th>7</th> </tr> </thead> <tbody> <tr> <td>0</td> <td>17</td> <td>18</td> <td>19</td> <td>20</td> <td>21</td> </tr> <tr> <td>2</td> <td>15</td> <td>16</td> <td>17</td> <td>18</td> <td>19</td> </tr> </tbody> </table> <p style="text-align: center;">$H=14+K-D$</p>	H mm	K mm					3	4	5	6	7	0	17	18	19	20	21	2	15	16	17	18	19
H mm	K mm																								
	3	4	5	6	7																				
0	17	18	19	20	21																				
2	15	16	17	18	19																				
ZKA02B (Half Overlay)																									
		<table border="1"> <thead> <tr> <th rowspan="2">H mm</th> <th colspan="5">K mm</th> </tr> <tr> <th>3</th> <th>4</th> <th>5</th> <th>6</th> <th>7</th> </tr> </thead> <tbody> <tr> <td>0</td> <td>8</td> <td>9</td> <td>10</td> <td>11</td> <td>12</td> </tr> <tr> <td>2</td> <td>6</td> <td>7</td> <td>8</td> <td>9</td> <td>10</td> </tr> </tbody> </table> <p style="text-align: center;">$H=5+K-D$</p>	H mm	K mm					3	4	5	6	7	0	8	9	10	11	12	2	6	7	8	9	10
H mm	K mm																								
	3	4	5	6	7																				
0	8	9	10	11	12																				
2	6	7	8	9	10																				
ZKA02C (Insert)																									
		<table border="1"> <thead> <tr> <th rowspan="2">H mm</th> <th colspan="5">K mm</th> </tr> <tr> <th>3</th> <th>4</th> <th>5</th> <th>6</th> <th>7</th> </tr> </thead> <tbody> <tr> <td>0</td> <td>-1</td> <td>-2</td> <td>-3</td> <td>-4</td> <td>-5</td> </tr> <tr> <td>2</td> <td>1</td> <td>0</td> <td>-1</td> <td>-2</td> <td>-3</td> </tr> </tbody> </table> <p style="text-align: center;">$H=-2+K-A$</p>	H mm	K mm					3	4	5	6	7	0	-1	-2	-3	-4	-5	2	1	0	-1	-2	-3
H mm	K mm																								
	3	4	5	6	7																				
0	-1	-2	-3	-4	-5																				
2	1	0	-1	-2	-3																				



Opening Angle: 105°
Door Thickness: 14-21 mm
Distance to door edge (K): 3-7 mm
Depth of hinge cup: 11.3 mm
Diameter of hinge cup: 35 mm
Distance of two hole center: 48 mm

Installation Diagram

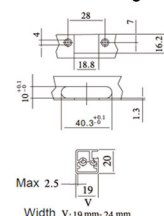

One Way Soft Closing Clip-on Hinge (Al. Door)



ZKA12A (Full Overlay)																									
		<table border="1"> <thead> <tr> <th rowspan="2">H mm</th> <th colspan="5">K mm</th> </tr> <tr> <th>3</th> <th>4</th> <th>5</th> <th>6</th> <th>7</th> </tr> </thead> <tbody> <tr> <td>0</td> <td>17</td> <td>18</td> <td>19</td> <td>20</td> <td>21</td> </tr> <tr> <td>2</td> <td>15</td> <td>16</td> <td>17</td> <td>18</td> <td>19</td> </tr> </tbody> </table> <p>H=14+K-D</p>	H mm	K mm					3	4	5	6	7	0	17	18	19	20	21	2	15	16	17	18	19
H mm	K mm																								
	3	4	5	6	7																				
0	17	18	19	20	21																				
2	15	16	17	18	19																				
ZKA12B (Half Overlay)																									
		<table border="1"> <thead> <tr> <th rowspan="2">H mm</th> <th colspan="5">K mm</th> </tr> <tr> <th>3</th> <th>4</th> <th>5</th> <th>6</th> <th>7</th> </tr> </thead> <tbody> <tr> <td>0</td> <td>8</td> <td>9</td> <td>10</td> <td>11</td> <td>12</td> </tr> <tr> <td>2</td> <td>6</td> <td>7</td> <td>8</td> <td>9</td> <td>10</td> </tr> </tbody> </table> <p>H=5+K-D</p>	H mm	K mm					3	4	5	6	7	0	8	9	10	11	12	2	6	7	8	9	10
H mm	K mm																								
	3	4	5	6	7																				
0	8	9	10	11	12																				
2	6	7	8	9	10																				
ZKA12C (Insert)																									
		<table border="1"> <thead> <tr> <th rowspan="2">H mm</th> <th colspan="5">K mm</th> </tr> <tr> <th>3</th> <th>4</th> <th>5</th> <th>6</th> <th>7</th> </tr> </thead> <tbody> <tr> <td>0</td> <td>-1</td> <td>-2</td> <td>-3</td> <td>-4</td> <td>-5</td> </tr> <tr> <td>2</td> <td>1</td> <td>0</td> <td>-1</td> <td>-2</td> <td>-3</td> </tr> </tbody> </table> <p>H=-2+K-A</p>	H mm	K mm					3	4	5	6	7	0	-1	-2	-3	-4	-5	2	1	0	-1	-2	-3
H mm	K mm																								
	3	4	5	6	7																				
0	-1	-2	-3	-4	-5																				
2	1	0	-1	-2	-3																				



Opening Angle: 105°
Door Thickness: 14-21 mm
Distance to door edge (K): 3-7 mm
Depth of hinge cup: 11.3 mm
Diameter of hinge cup: 35 mm
Distance of two hole center: 48 mm

Installation Diagram

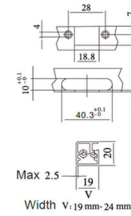

45°/90°/135° Soft Closing Clip-on Angle Hinge



45°			<table border="1"> <thead> <tr> <th rowspan="2">H mm</th> <th colspan="4">K mm</th> </tr> <tr> <th>4.0</th> <th>5.0</th> <th>6.0</th> <th>7.0</th> </tr> </thead> <tbody> <tr> <td>0</td> <td>37 3.3</td> <td>36 4.0</td> <td>35 4.7</td> <td>35 5.4</td> </tr> <tr> <td>2</td> <td>37 1.3</td> <td>36 2.0</td> <td>35 2.7</td> <td>35 3.4</td> </tr> </tbody> </table>	H mm	K mm				4.0	5.0	6.0	7.0	0	37 3.3	36 4.0	35 4.7	35 5.4	2	37 1.3	36 2.0	35 2.7	35 3.4
H mm	K mm																					
	4.0	5.0	6.0	7.0																		
0	37 3.3	36 4.0	35 4.7	35 5.4																		
2	37 1.3	36 2.0	35 2.7	35 3.4																		
90°			<table border="1"> <thead> <tr> <th rowspan="2">H mm</th> <th colspan="4">K mm</th> </tr> <tr> <th>4.0</th> <th>5.0</th> <th>6.0</th> <th>7.0</th> </tr> </thead> <tbody> <tr> <td>0</td> <td>37 4.0</td> <td>36 4.1</td> <td>35 4.3</td> <td>35 5.2</td> </tr> <tr> <td>2</td> <td>37 1.3</td> <td>36 2.1</td> <td>35 2.3</td> <td>35 3.2</td> </tr> </tbody> </table>	H mm	K mm				4.0	5.0	6.0	7.0	0	37 4.0	36 4.1	35 4.3	35 5.2	2	37 1.3	36 2.1	35 2.3	35 3.2
H mm	K mm																					
	4.0	5.0	6.0	7.0																		
0	37 4.0	36 4.1	35 4.3	35 5.2																		
2	37 1.3	36 2.1	35 2.3	35 3.2																		
135°			<table border="1"> <thead> <tr> <th rowspan="2">H mm</th> <th colspan="4">K mm</th> </tr> <tr> <th>4.0</th> <th>5.0</th> <th>6.0</th> <th>7.0</th> </tr> </thead> <tbody> <tr> <td>0</td> <td>37 3.3</td> <td>36 4.0</td> <td>35 4.7</td> <td>35 5.4</td> </tr> <tr> <td>2</td> <td>37 1.3</td> <td>36 2.0</td> <td>35 2.7</td> <td>35 3.4</td> </tr> </tbody> </table>	H mm	K mm				4.0	5.0	6.0	7.0	0	37 3.3	36 4.0	35 4.7	35 5.4	2	37 1.3	36 2.0	35 2.7	35 3.4
H mm	K mm																					
	4.0	5.0	6.0	7.0																		
0	37 3.3	36 4.0	35 4.7	35 5.4																		
2	37 1.3	36 2.0	35 2.7	35 3.4																		



Opening Angle: 45°/ 90°/ 135°
Door Thickness: 14-21 mm
Distance to door edge (K): 3-7 mm
Depth of hinge cup: 11.3 mm
Diameter of hinge cup: 35 mm
Distance of two hole center: 48 mm

Installation Diagram

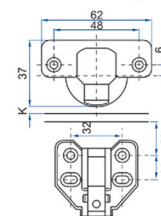

Two Way Soft Closing Fixing Hinge



ZKA23A (Full Overlay)																									
		<table border="1"> <thead> <tr> <th rowspan="2">H mm</th> <th colspan="5">K mm</th> </tr> <tr> <th>3</th> <th>4</th> <th>5</th> <th>6</th> <th>7</th> </tr> </thead> <tbody> <tr> <td>0</td> <td>18</td> <td>19</td> <td>20</td> <td>21</td> <td>22</td> </tr> <tr> <td>2</td> <td>16</td> <td>17</td> <td>18</td> <td>19</td> <td>20</td> </tr> </tbody> </table> <p style="text-align: center;">$H=14+K-D$</p>	H mm	K mm					3	4	5	6	7	0	18	19	20	21	22	2	16	17	18	19	20
H mm	K mm																								
	3	4	5	6	7																				
0	18	19	20	21	22																				
2	16	17	18	19	20																				
ZKA23B (Half Overlay)																									
		<table border="1"> <thead> <tr> <th rowspan="2">H mm</th> <th colspan="5">K mm</th> </tr> <tr> <th>3</th> <th>4</th> <th>5</th> <th>6</th> <th>7</th> </tr> </thead> <tbody> <tr> <td>0</td> <td>9</td> <td>10</td> <td>11</td> <td>12</td> <td>13</td> </tr> <tr> <td>2</td> <td>7</td> <td>8</td> <td>9</td> <td>10</td> <td>11</td> </tr> </tbody> </table> <p style="text-align: center;">$H=5+K-D$</p>	H mm	K mm					3	4	5	6	7	0	9	10	11	12	13	2	7	8	9	10	11
H mm	K mm																								
	3	4	5	6	7																				
0	9	10	11	12	13																				
2	7	8	9	10	11																				
ZKA23C (Insert)																									
		<table border="1"> <thead> <tr> <th rowspan="2">H mm</th> <th colspan="5">K mm</th> </tr> <tr> <th>3</th> <th>4</th> <th>5</th> <th>6</th> <th>7</th> </tr> </thead> <tbody> <tr> <td>0</td> <td>-2</td> <td>-3</td> <td>-4</td> <td>-5</td> <td>-6</td> </tr> <tr> <td>2</td> <td>0</td> <td>-1</td> <td>-2</td> <td>-3</td> <td>-4</td> </tr> </tbody> </table> <p style="text-align: center;">$H=-2+K-A$</p>	H mm	K mm					3	4	5	6	7	0	-2	-3	-4	-5	-6	2	0	-1	-2	-3	-4
H mm	K mm																								
	3	4	5	6	7																				
0	-2	-3	-4	-5	-6																				
2	0	-1	-2	-3	-4																				



Opening Angle: 105°
Door Thickness: 14-21 mm
Distance to door edge (K): 3-7 mm
Depth of hinge cup: 11.3 mm
Diameter of hinge cup: 35 mm
Distance of two hole center: 48 mm

Installation Diagram

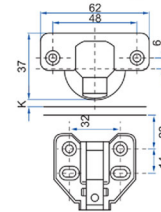

Two Way Soft Closing Clip-on Hinge



ZKE11A (Full Overlay)																									
		<table border="1"> <thead> <tr> <th rowspan="2">H mm</th> <th colspan="5">K mm</th> </tr> <tr> <th>3</th> <th>4</th> <th>5</th> <th>6</th> <th>7</th> </tr> </thead> <tbody> <tr> <td>0</td> <td>17</td> <td>18</td> <td>19</td> <td>20</td> <td>21</td> </tr> <tr> <td>2</td> <td>15</td> <td>16</td> <td>17</td> <td>18</td> <td>19</td> </tr> </tbody> </table> <p style="text-align: center;">$H=14+K-D$</p>	H mm	K mm					3	4	5	6	7	0	17	18	19	20	21	2	15	16	17	18	19
H mm	K mm																								
	3	4	5	6	7																				
0	17	18	19	20	21																				
2	15	16	17	18	19																				
ZKE11B (Half Overlay)																									
		<table border="1"> <thead> <tr> <th rowspan="2">H mm</th> <th colspan="5">K mm</th> </tr> <tr> <th>3</th> <th>4</th> <th>5</th> <th>6</th> <th>7</th> </tr> </thead> <tbody> <tr> <td>0</td> <td>8</td> <td>9</td> <td>10</td> <td>11</td> <td>12</td> </tr> <tr> <td>2</td> <td>6</td> <td>7</td> <td>8</td> <td>9</td> <td>10</td> </tr> </tbody> </table> <p style="text-align: center;">$H=5+K-D$</p>	H mm	K mm					3	4	5	6	7	0	8	9	10	11	12	2	6	7	8	9	10
H mm	K mm																								
	3	4	5	6	7																				
0	8	9	10	11	12																				
2	6	7	8	9	10																				
ZKE11C (Insert)																									
		<table border="1"> <thead> <tr> <th rowspan="2">H mm</th> <th colspan="5">K mm</th> </tr> <tr> <th>3</th> <th>4</th> <th>5</th> <th>6</th> <th>7</th> </tr> </thead> <tbody> <tr> <td>0</td> <td>-1</td> <td>-2</td> <td>-3</td> <td>-4</td> <td>-5</td> </tr> <tr> <td>2</td> <td>1</td> <td>0</td> <td>-1</td> <td>-2</td> <td>-3</td> </tr> </tbody> </table> <p style="text-align: center;">$H=-2+K-A$</p>	H mm	K mm					3	4	5	6	7	0	-1	-2	-3	-4	-5	2	1	0	-1	-2	-3
H mm	K mm																								
	3	4	5	6	7																				
0	-1	-2	-3	-4	-5																				
2	1	0	-1	-2	-3																				



Opening Angle: 105°
Door Thickness: 14-21 mm
Distance to door edge (K): 3-7 mm
Depth of hinge cup: 11.3 mm
Diameter of hinge cup: 35 mm
Distance of two hole center: 48 mm

Installation Diagram

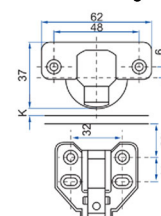

One Way Soft Closing Hinge



ZKB01A (Full Overlay)																									
		<table border="1"> <thead> <tr> <th rowspan="2">H mm</th> <th colspan="5">K mm</th> </tr> <tr> <th>3</th> <th>4</th> <th>5</th> <th>6</th> <th>7</th> </tr> </thead> <tbody> <tr> <td>0</td> <td>18</td> <td>19</td> <td>20</td> <td>21</td> <td>22</td> </tr> <tr> <td>2</td> <td>16</td> <td>17</td> <td>18</td> <td>19</td> <td>20</td> </tr> </tbody> </table> <p style="text-align: center;">$H=14+K-D$</p>	H mm	K mm					3	4	5	6	7	0	18	19	20	21	22	2	16	17	18	19	20
H mm	K mm																								
	3	4	5	6	7																				
0	18	19	20	21	22																				
2	16	17	18	19	20																				
ZKB01B (Half Overlay)																									
		<table border="1"> <thead> <tr> <th rowspan="2">H mm</th> <th colspan="5">K mm</th> </tr> <tr> <th>3</th> <th>4</th> <th>5</th> <th>6</th> <th>7</th> </tr> </thead> <tbody> <tr> <td>0</td> <td>9</td> <td>10</td> <td>11</td> <td>12</td> <td>13</td> </tr> <tr> <td>2</td> <td>7</td> <td>8</td> <td>9</td> <td>10</td> <td>11</td> </tr> </tbody> </table> <p style="text-align: center;">$H=5+K-D$</p>	H mm	K mm					3	4	5	6	7	0	9	10	11	12	13	2	7	8	9	10	11
H mm	K mm																								
	3	4	5	6	7																				
0	9	10	11	12	13																				
2	7	8	9	10	11																				
ZKB01C (Insert)																									
		<table border="1"> <thead> <tr> <th rowspan="2">H mm</th> <th colspan="5">K mm</th> </tr> <tr> <th>3</th> <th>4</th> <th>5</th> <th>6</th> <th>7</th> </tr> </thead> <tbody> <tr> <td>0</td> <td>-2</td> <td>-3</td> <td>-4</td> <td>-5</td> <td>-6</td> </tr> <tr> <td>2</td> <td>0</td> <td>-1</td> <td>-2</td> <td>-3</td> <td>-4</td> </tr> </tbody> </table> <p style="text-align: center;">$H=-2+K-A$</p>	H mm	K mm					3	4	5	6	7	0	-2	-3	-4	-5	-6	2	0	-1	-2	-3	-4
H mm	K mm																								
	3	4	5	6	7																				
0	-2	-3	-4	-5	-6																				
2	0	-1	-2	-3	-4																				



Opening Angle: 105°
Door Thickness: 14-21 mm
Distance to door edge (K): 3-7 mm
Depth of hinge cup: 11.3 mm
Diameter of hinge cup: 35 mm
Distance of two hole center: 48 mm

Installation Diagram

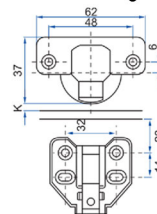

Two Way Soft Closing Hinge



ZKB11A (Full Overlay)																									
		<table border="1"> <thead> <tr> <th rowspan="2">H mm</th> <th colspan="5">K mm</th> </tr> <tr> <th>3</th> <th>4</th> <th>5</th> <th>6</th> <th>7</th> </tr> </thead> <tbody> <tr> <td>0</td> <td>17</td> <td>18</td> <td>19</td> <td>20</td> <td>21</td> </tr> <tr> <td>2</td> <td>15</td> <td>16</td> <td>17</td> <td>18</td> <td>19</td> </tr> </tbody> </table> <p style="text-align: center;">$H=14+K-D$</p>	H mm	K mm					3	4	5	6	7	0	17	18	19	20	21	2	15	16	17	18	19
H mm	K mm																								
	3	4	5	6	7																				
0	17	18	19	20	21																				
2	15	16	17	18	19																				
ZKB11B (Half Overlay)																									
		<table border="1"> <thead> <tr> <th rowspan="2">H mm</th> <th colspan="5">K mm</th> </tr> <tr> <th>3</th> <th>4</th> <th>5</th> <th>6</th> <th>7</th> </tr> </thead> <tbody> <tr> <td>0</td> <td>8</td> <td>9</td> <td>10</td> <td>11</td> <td>12</td> </tr> <tr> <td>2</td> <td>6</td> <td>7</td> <td>8</td> <td>9</td> <td>10</td> </tr> </tbody> </table> <p style="text-align: center;">$H=5+K-D$</p>	H mm	K mm					3	4	5	6	7	0	8	9	10	11	12	2	6	7	8	9	10
H mm	K mm																								
	3	4	5	6	7																				
0	8	9	10	11	12																				
2	6	7	8	9	10																				
ZKB11C (Insert)																									
		<table border="1"> <thead> <tr> <th rowspan="2">H mm</th> <th colspan="5">K mm</th> </tr> <tr> <th>3</th> <th>4</th> <th>5</th> <th>6</th> <th>7</th> </tr> </thead> <tbody> <tr> <td>0</td> <td>-1</td> <td>-2</td> <td>-3</td> <td>-4</td> <td>-5</td> </tr> <tr> <td>2</td> <td>1</td> <td>0</td> <td>-1</td> <td>-2</td> <td>-3</td> </tr> </tbody> </table> <p style="text-align: center;">$H=-2+K-A$</p>	H mm	K mm					3	4	5	6	7	0	-1	-2	-3	-4	-5	2	1	0	-1	-2	-3
H mm	K mm																								
	3	4	5	6	7																				
0	-1	-2	-3	-4	-5																				
2	1	0	-1	-2	-3																				



Opening Angle: 105°
Door Thickness: 14-21 mm
Distance to door edge (K): 3-7 mm
Depth of hinge cup: 11.3 mm
Diameter of hinge cup: 35 mm
Distance of two hole center: 48 mm

Installation Diagram

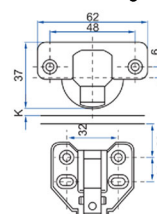

One Way Soft Closing Hinge



ZKA23A (Full Overlay)																									
		<table border="1"> <thead> <tr> <th rowspan="2">H mm</th> <th colspan="5">K mm</th> </tr> <tr> <th>3</th> <th>4</th> <th>5</th> <th>6</th> <th>7</th> </tr> </thead> <tbody> <tr> <td>0</td> <td>17</td> <td>18</td> <td>19</td> <td>20</td> <td>21</td> </tr> <tr> <td>2</td> <td>15</td> <td>16</td> <td>17</td> <td>18</td> <td>19</td> </tr> </tbody> </table> <p style="text-align: center;">$H=14+K-D$</p>	H mm	K mm					3	4	5	6	7	0	17	18	19	20	21	2	15	16	17	18	19
H mm	K mm																								
	3	4	5	6	7																				
0	17	18	19	20	21																				
2	15	16	17	18	19																				
ZKA23B (Half Overlay)																									
		<table border="1"> <thead> <tr> <th rowspan="2">H mm</th> <th colspan="5">K mm</th> </tr> <tr> <th>3</th> <th>4</th> <th>5</th> <th>6</th> <th>7</th> </tr> </thead> <tbody> <tr> <td>0</td> <td>8</td> <td>9</td> <td>10</td> <td>11</td> <td>12</td> </tr> <tr> <td>2</td> <td>6</td> <td>7</td> <td>8</td> <td>9</td> <td>10</td> </tr> </tbody> </table> <p style="text-align: center;">$H=5+K-D$</p>	H mm	K mm					3	4	5	6	7	0	8	9	10	11	12	2	6	7	8	9	10
H mm	K mm																								
	3	4	5	6	7																				
0	8	9	10	11	12																				
2	6	7	8	9	10																				
ZKA23C (Insert)																									
		<table border="1"> <thead> <tr> <th rowspan="2">H mm</th> <th colspan="5">K mm</th> </tr> <tr> <th>3</th> <th>4</th> <th>5</th> <th>6</th> <th>7</th> </tr> </thead> <tbody> <tr> <td>0</td> <td>-1</td> <td>-2</td> <td>-3</td> <td>-4</td> <td>-5</td> </tr> <tr> <td>2</td> <td>1</td> <td>0</td> <td>-1</td> <td>-2</td> <td>-3</td> </tr> </tbody> </table> <p style="text-align: center;">$H=-2+K-A$</p>	H mm	K mm					3	4	5	6	7	0	-1	-2	-3	-4	-5	2	1	0	-1	-2	-3
H mm	K mm																								
	3	4	5	6	7																				
0	-1	-2	-3	-4	-5																				
2	1	0	-1	-2	-3																				



Opening Angle: 105°
Door Thickness: 14-21 mm
Distance to door edge (K): 3-7 mm
Depth of hinge cup: 11.3 mm
Diameter of hinge cup: 35 mm
Distance of two hole center: 48 mm

Installation Diagram

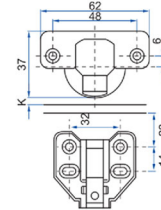

165° Soft Closing Angle Door Hinge



ZKJ065A (Full Overlay)																													
		<table border="1"> <thead> <tr> <th rowspan="2">H mm</th> <th colspan="6">K mm</th> </tr> <tr> <th>3</th> <th>4</th> <th>5</th> <th>6</th> <th>7</th> <th>8</th> </tr> </thead> <tbody> <tr> <td>0</td> <td>17</td> <td>18</td> <td>19</td> <td>20</td> <td>21</td> <td>22</td> </tr> <tr> <td>2</td> <td>15</td> <td>16</td> <td>17</td> <td>18</td> <td>19</td> <td>20</td> </tr> </tbody> </table> <p style="text-align: center;">$H=14+K-D$</p>	H mm	K mm						3	4	5	6	7	8	0	17	18	19	20	21	22	2	15	16	17	18	19	20
H mm	K mm																												
	3	4	5	6	7	8																							
0	17	18	19	20	21	22																							
2	15	16	17	18	19	20																							
ZKJ065B (Half Overlay)																													
		<table border="1"> <thead> <tr> <th rowspan="2">H mm</th> <th colspan="6">K mm</th> </tr> <tr> <th>3</th> <th>4</th> <th>5</th> <th>6</th> <th>7</th> <th>8</th> </tr> </thead> <tbody> <tr> <td>0</td> <td>8</td> <td>9</td> <td>10</td> <td>11</td> <td>12</td> <td>13</td> </tr> <tr> <td>2</td> <td>6</td> <td>7</td> <td>8</td> <td>9</td> <td>10</td> <td>11</td> </tr> </tbody> </table> <p style="text-align: center;">$H=5+K-D$</p>	H mm	K mm						3	4	5	6	7	8	0	8	9	10	11	12	13	2	6	7	8	9	10	11
H mm	K mm																												
	3	4	5	6	7	8																							
0	8	9	10	11	12	13																							
2	6	7	8	9	10	11																							
ZKJ065C (Insert)																													
		<table border="1"> <thead> <tr> <th rowspan="2">H mm</th> <th colspan="5">K mm</th> </tr> <tr> <th>3</th> <th>4</th> <th>5</th> <th>6</th> <th>7</th> </tr> </thead> <tbody> <tr> <td>0</td> <td>-1</td> <td>-2</td> <td>-3</td> <td>-4</td> <td>-5</td> </tr> <tr> <td>2</td> <td>1</td> <td>0</td> <td>-1</td> <td>-2</td> <td>-3</td> </tr> </tbody> </table> <p style="text-align: center;">$H=-2+K-A$</p>	H mm	K mm					3	4	5	6	7	0	-1	-2	-3	-4	-5	2	1	0	-1	-2	-3				
H mm	K mm																												
	3	4	5	6	7																								
0	-1	-2	-3	-4	-5																								
2	1	0	-1	-2	-3																								

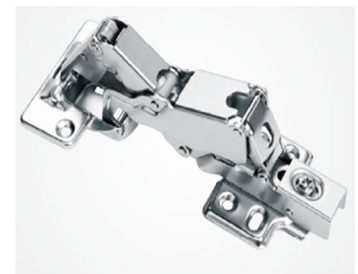

Opening Angle: 165°
Door Thickness: 14-21 mm
Distance to door edge (K): 3-8 mm
Depth of hinge cup: 11.3 mm
Diameter of hinge cup: 35 mm
Distance of two hole center: 48 mm

Installation Diagram

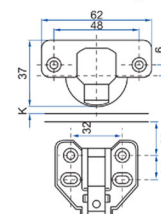

165° Soft Closing Clip-on Angle Door Hinge



ZKJ165A (Full Overlay)																													
		<table border="1"> <thead> <tr> <th rowspan="2">H mm</th> <th colspan="6">K mm</th> </tr> <tr> <th>3</th> <th>4</th> <th>5</th> <th>6</th> <th>7</th> <th>8</th> </tr> </thead> <tbody> <tr> <td>0</td> <td>17</td> <td>18</td> <td>19</td> <td>20</td> <td>21</td> <td>22</td> </tr> <tr> <td>2</td> <td>15</td> <td>16</td> <td>17</td> <td>18</td> <td>19</td> <td>20</td> </tr> </tbody> </table> <p style="text-align: center;">$H=14+K-D$</p>	H mm	K mm						3	4	5	6	7	8	0	17	18	19	20	21	22	2	15	16	17	18	19	20
H mm	K mm																												
	3	4	5	6	7	8																							
0	17	18	19	20	21	22																							
2	15	16	17	18	19	20																							
ZKJ165B (Half Overlay)																													
		<table border="1"> <thead> <tr> <th rowspan="2">H mm</th> <th colspan="6">K mm</th> </tr> <tr> <th>3</th> <th>4</th> <th>5</th> <th>6</th> <th>7</th> <th>8</th> </tr> </thead> <tbody> <tr> <td>0</td> <td>8</td> <td>9</td> <td>10</td> <td>11</td> <td>12</td> <td>13</td> </tr> <tr> <td>2</td> <td>6</td> <td>7</td> <td>8</td> <td>9</td> <td>10</td> <td>11</td> </tr> </tbody> </table> <p style="text-align: center;">$H=5+K-D$</p>	H mm	K mm						3	4	5	6	7	8	0	8	9	10	11	12	13	2	6	7	8	9	10	11
H mm	K mm																												
	3	4	5	6	7	8																							
0	8	9	10	11	12	13																							
2	6	7	8	9	10	11																							
ZKJ165C (Insert)																													
		<table border="1"> <thead> <tr> <th rowspan="2">H mm</th> <th colspan="5">K mm</th> </tr> <tr> <th>3</th> <th>4</th> <th>5</th> <th>6</th> <th>7</th> </tr> </thead> <tbody> <tr> <td>0</td> <td>-1</td> <td>-2</td> <td>-3</td> <td>-4</td> <td>-5</td> </tr> <tr> <td>2</td> <td>1</td> <td>0</td> <td>-1</td> <td>-2</td> <td>-3</td> </tr> </tbody> </table> <p style="text-align: center;">$H=-2+K-A$</p>	H mm	K mm					3	4	5	6	7	0	-1	-2	-3	-4	-5	2	1	0	-1	-2	-3				
H mm	K mm																												
	3	4	5	6	7																								
0	-1	-2	-3	-4	-5																								
2	1	0	-1	-2	-3																								



Opening Angle: 165°
Door Thickness: 14-21 mm
Distance to door edge (K): 3-8 mm
Depth of hinge cup: 11.3 mm
Diameter of hinge cup: 35 mm
Distance of two hole center: 48 mm

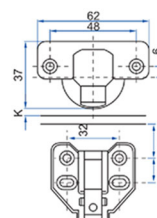

Two Way Soft Closing Clip-on Hinge(Thick Door)



ZHH01A (Full Overlay)																					
		<table border="1"> <thead> <tr> <th rowspan="2">H mm</th> <th colspan="4">K mm</th> </tr> <tr> <th>3</th> <th>4</th> <th>5</th> <th>6</th> </tr> </thead> <tbody> <tr> <td>0</td> <td>19</td> <td>20</td> <td>21</td> <td>22</td> </tr> <tr> <td>2</td> <td>17</td> <td>18</td> <td>19</td> <td>20</td> </tr> </tbody> </table> <p style="text-align: center;">$H=16+K-D$</p>	H mm	K mm				3	4	5	6	0	19	20	21	22	2	17	18	19	20
H mm	K mm																				
	3	4	5	6																	
0	19	20	21	22																	
2	17	18	19	20																	
ZHH01B (Half Overlay)																					
		<table border="1"> <thead> <tr> <th rowspan="2">H mm</th> <th colspan="4">K mm</th> </tr> <tr> <th>3</th> <th>4</th> <th>5</th> <th>6</th> </tr> </thead> <tbody> <tr> <td>0</td> <td>10</td> <td>11</td> <td>12</td> <td>13</td> </tr> <tr> <td>2</td> <td>8</td> <td>9</td> <td>10</td> <td>11</td> </tr> </tbody> </table> <p style="text-align: center;">$H=7+K-D$</p>	H mm	K mm				3	4	5	6	0	10	11	12	13	2	8	9	10	11
H mm	K mm																				
	3	4	5	6																	
0	10	11	12	13																	
2	8	9	10	11																	
ZHH01C (Insert)																					
		<table border="1"> <thead> <tr> <th rowspan="2">H mm</th> <th colspan="4">K mm</th> </tr> <tr> <th>3</th> <th>4</th> <th>5</th> <th>6</th> </tr> </thead> <tbody> <tr> <td>0</td> <td>0</td> <td>-1</td> <td>-2</td> <td>-3</td> </tr> <tr> <td>2</td> <td>2</td> <td>1</td> <td>0</td> <td>-1</td> </tr> </tbody> </table> <p style="text-align: center;">$H=-3+K-A$</p>	H mm	K mm				3	4	5	6	0	0	-1	-2	-3	2	2	1	0	-1
H mm	K mm																				
	3	4	5	6																	
0	0	-1	-2	-3																	
2	2	1	0	-1																	



Opening Angle: 100°
Door Thickness: 16-26 mm
Distance to door edge (K): 3-7 mm
Depth of hinge cup: 11.3 mm
Diameter of hinge cup: 35 mm
Distance of two hole center: 48 mm

Installation Diagram

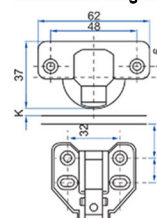

SHORT ARM HYDRAULIC HINGE

ZHS-07 AMERICAN STYLE SOFT CLOSE HINGE



Full Overlay



Half Overlay



Insert



Stainless Steel
Thickness: 1.2mm
Open Angle: 105°
Cup Depth: 11.5mm
Cup Dia.: 35mm
Door Panel: 15-19mm

zū[®] ZIPLUS
FURNITURE HARDWARE

ZIPLUS (H.K.) HARDWARE CO., LIMITED

No.2, Liuzu Gang, Cuntou Village, Baixi Xiqiao
Town, Nanhai District, Foshan City, Guangdong,
China

Wechat/Whatsapp: +86 13794633232 (Kevin)
kevin@ziplus.com

www.ziplus.com

© Ziplus (H.K.) Hardware Co., Limited 2023. May 2023.

Please be aware that the information within this catalog may contain technical inaccuracies or typographical errors and is subject to change by our company. Ziplus (H.K.) Hardware Co., Limited retains the right to modify our products without prior notice.

Reproduction of this catalog and its contents is strictly prohibited.