

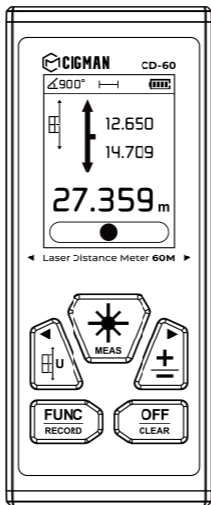

# Bilateral Laser Distance Meter

## CD-60 User manual





Contact us: [support@cigman.com](mailto:support@cigman.com)

## Languages

User manual - English .....	1 - 16
Bedienungsanleitung - Deutsch .....	17 - 32
Manuel d'instructions - Français .....	33 - 48
Istruzioni per l'uso - Italiano .....	49 - 64
Manual de instruccin - Español .....	65 - 80
取扱説明書 - 日本語 .....	81 - 96
Three Years Warranty .....	97

# Safety Regulations

 Before using the instrument for the first time, please read the safety clauses and operating instructions carefully.

 Failure to use the instrument in accordance with the operating methods guided in this manual may cause damage to the instrument, affect measurement accuracy, and cause personal injury to the user or a third party harm.

 Do not open or repair the instrument by yourself in any way, and it is strictly forbidden to illegally modify or change the performance of the laser transmitter of the instrument. Please keep the instrument properly, do not place it in a place where children can touch it, and avoid use by unrelated personnel.

 It is strictly forbidden to irradiate the eyes and other parts of the body of oneself or others with the laser of the instrument, and it is strictly forbidden to irradiate the laser on the surface of highly reflective objects.

 The electromagnetic radiation of the instrument may cause interference with other equipment and devices. Please do not use the instrument near airplanes or medical equipment, and do not use the instrument in flammable and explosive environments.

 Discarded instruments cannot be disposed of together with domestic waste. Please dispose of discarded instruments according to relevant national or local laws and regulations.

# Product Features

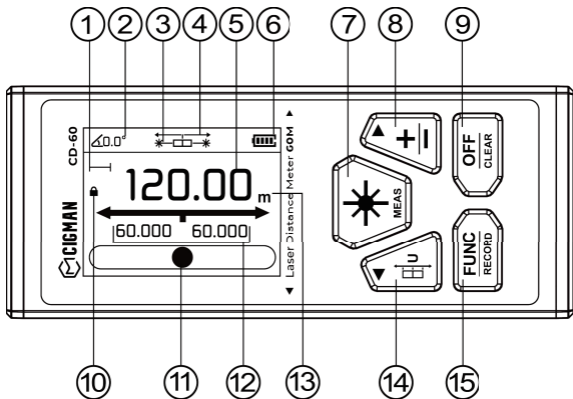

① Measurement mode	② Angle indicator	③ Laser indicator
④ Benchmark indicator	⑤ Main display area	⑥ Power indicator
⑦ Switch on/ Measurement button	⑧ Addition/Subtraction/ Screen lock button	⑨ Switch off/Clear button
⑩ Screen lock indicator	⑪ Level bubble	⑫ Auxiliary display area
⑬ Unit display	⑭ Unit switch/ benchmark measurement	⑮ Function and record button



# Basic Function

## ● Switch on/off the instrument

In the shutdown state, long press the  button. The instrument starts and enters the waiting test mode.

In the running state, long press the  button to turn off the instrument. If there is no operation within 180 seconds, the instrument will be automatically closed.

## ● Unit setting

Long press the  button to enter the unit switch status, the instrument provides 6 units to choose from.

Unit	Length	Area	Volume
1	0.000 m	0.000 m <sup>2</sup>	0.000 m <sup>3</sup>
2	0.00 m	0.00 m <sup>2</sup>	0.00 m <sup>3</sup>
3	0.0 in	0.00 ft <sup>2</sup>	0.00 ft <sup>3</sup>
4	0 $\frac{1}{16}$ in	0.00 ft <sup>2</sup>	0.00 ft <sup>3</sup>
5	0'00" $\frac{1}{16}$	0.00 ft <sup>2</sup>	0.00 ft <sup>3</sup>
6	0.00 ft	0.00 ft <sup>2</sup>	0.00 ft <sup>3</sup>

## ● Benchmark measurement setting

Short Press the  button to measure the benchmark, and the default setting is bilateral measurement.

bilateral measurement.

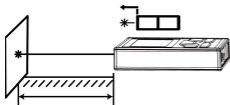

forward-left benchmark

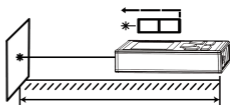

back-left benchmark

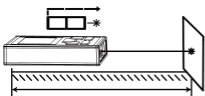

back-right benchmark

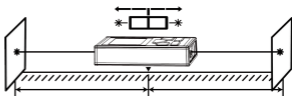

bilateral measurement

## ● Measurement mode selection

Short press the  button to enter mode selection. Display as follows:











Short press the  or  button to switch mode;



Short press the  button to select mode;

Short press the  button to return.

There are nine measurement modes in the instrument:

	Length measurement		Angle and height measurement
	Area measurement		Indirect height measurement
	Volume measurement		Hypotenuse measurement
	Wall area measurement		Double indirect height measurement
			Auxiliary height measurement

## ● Rotating the screen and locking

The instrument supports the automatic rotating screen, long press the  button to lock the direction of the screen, the screen displays the  icon. Long press the  button to cancel the screen direction lock.

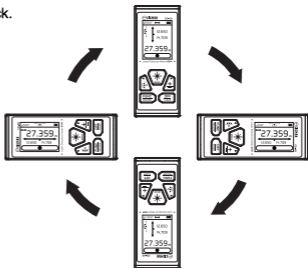

## ● Electronic level bubble

The instrument is attached to electronic horizontal bubble, which can measure the horizontal level of the plane.

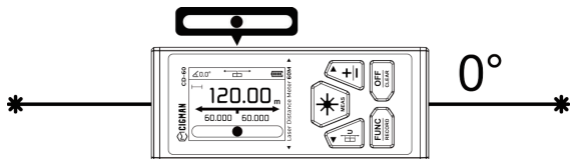

## ● Strong magnetic adsorption

There is a magnet on the back of the device, which can adsorb the surface of the metal.

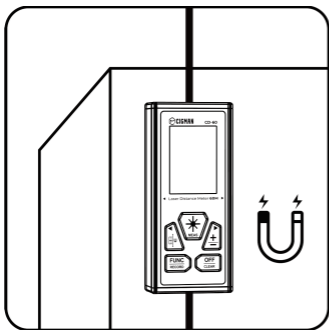

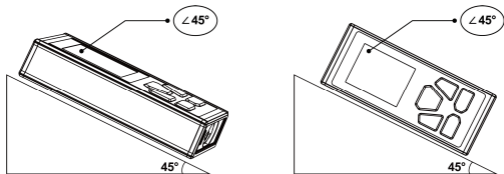

## ● Angle measurement

The instrument has a built-in dump sensor, which can measure the angle of the bottom side and the side of the side in real-time.







## Multiple measurement features

### ● Length mode-Single measurement :

Press the  button in the length mode, the device sends out a laser point to lock the measurement position. Then press the  button again to do the single distance data measurement. The reading shows in the main display area. On the bilateral measurement, the auxiliary display area displays the distance between the left and right ends.

### ● Length mode-continuous measurement :

In the length mode, press and hold the  button to enter the continuous measurement state, and the screen displays real-time measurement data, maximum value, and minimum value; short press the  button or  button to once to pause the measurement, press these two buttons again to exit the continuous measurement mode.

Midpoint search: Set the benchmark to a bilateral benchmark, Long press the  button to start the continuous measurement, and find the midpoint according to the following prompts. (When using the bilateral laser to measure, the left and right readings may have a 1mm error.)

Horizontal screen display:

1. The screen displays **【←】**, please move it to the left.
2. The screen displays **【→】**, please move it to the right.

Vertical screen display:

1. The screen displays **【↑】**, please move it up.
2. The screen displays **【↓】**, please move it down.

When the screen displays **→|←**, it means it is currently at the midpoint.

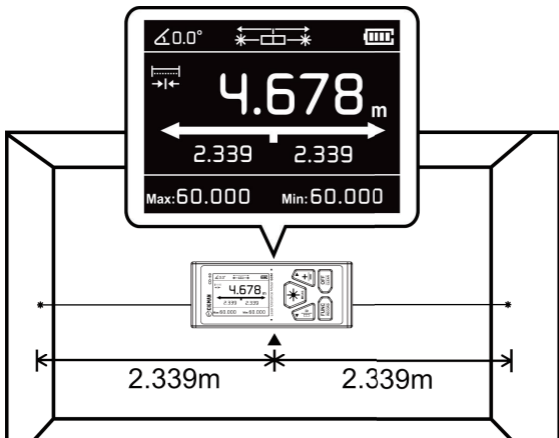

## ● Area measurement :

Press the  button to measure the first side (length);

Press the  button to measure the second side (width);

The instrument will automatically calculate the area and display it in the main display area. The auxiliary display area shows the length and width measurements. During the measurement, you can also press the  button to clear the current reading and re-measure.

## ● Volume measurement :

1. Press the  button to measure the first side (length);

2. Press the  button to measure the second side (width);

3. Press the  button to measure the third side (height);

4. The instrument will automatically calculate the volume and display it in the main display area. The auxiliary display area displays the measured values of the cube's length, width, and height.

During the measurement, you can also press the  button to clear the current reading and re-measure.

## ● Wall Area Measurement :

1. Press the  button to measure the height of the wall;

2. Press the  button to measure the width 1 of wall 1;

The instrument will automatically calculate the area of the wall = height x width 1;

3. Press the  button to measure the width 2 of wall 2;

The instrument will automatically calculate the sum of the area of the wall.

Sum of area = height x (width 1+width 2);

4. By analogy, press the  button to measure the width n of the wall n;

Sum of area = height x (width 1+width 2+...+width n);

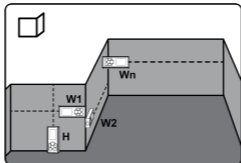

During the measurement, you can also press the **OFF CLEAR** button to clear the current reading and re-measure.

## ● Indirect Measurement:

① Measure the angle and height of a right triangle  (as shown in figure 1)

Press the  Button, and follow the prompts on the screen to measure the length of the hypotenuse (**a**);

The instrument can simultaneously measure the angle between the hypotenuse and the base-side ( **$\theta$** );

The instrument can automatically calculate the horizontal distance (**b**) and the vertical height (**h**).

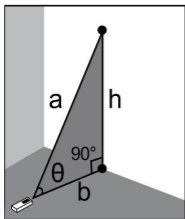

(figure 1)

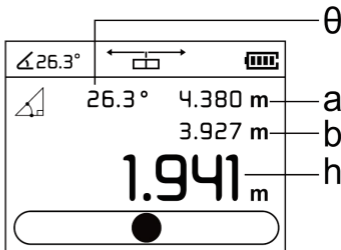



(screen display)



② Measure the height of a right triangle  (as shown in figure 2).

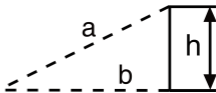

(as shown in figure 2).

1. Press the  button, and follow the prompts on the screen to measure the length of the hypotenuse (**a**);
2. Press the  button, then measure the length of the right-angled side (**b**);
3. The instrument will automatically calculate the height (**h**) of the triangle after the second measurement.



(figure 2)

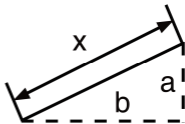

③ Measure the hypotenuse of a right triangle  (as shown in figure 3).

1. Press the  button to measure the length of a side according to the prompt on the screen (**a**);
2. Press the  button to measure the length of a right-angled edge (**b**);
3. The instrument will automatically calculate the hypotenuse (**x**) of the triangle after the second measurement.



(figure 3)

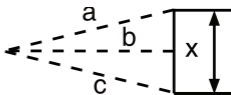

④ Measure the double indirect height of an isosceles triangle  (as shown in figure 4)

1. Press the  button, and follow the screen prompts to measure the length of one hypotenuse (**a**);
2. Press the  button, then measure the length of the right-angled edge (**b**);
3. Press the  button to measure the length of the other hypotenuse (**c**);
4. After the measurement, the instrument automatically calculates the height of the triangle (**x**).



(figure 4)

⑤ Measure the auxiliary height of the triangle  (as shown in figure 5)

1. Press the  button, and follow the prompts on the screen to measure the length of a hypotenuse (**a**);
2. Press the  button to measure the length of the other side (**b**);
3. Press the  button to measure the length of another hypotenuse (**c**);
4. After the measurement, the instrument will automatically calculate the auxiliary height (**x**) of the triangle.

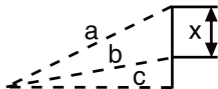

(figure 5)

### Notice:

In the Pythagorean measurement mode, the instrument can only calculate the length of the right-angled side which must be less than the hypotenuse. Otherwise, the instrument will display an error signal.

In the Pythagorean measurement mode, in order to ensure accuracy, it must be measured from the same starting point and measured in the order of hypotenuse and right angle.

## ● Addition and Subtraction measurement:

1. Length cumulative addition and subtraction



In length mode, measure a set of data.

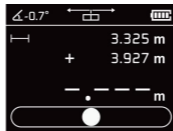

Short press the  button to enter the cumulative mode.



Then measure the data, the instrument will automatically accumulate and sum.

Short press the  button, "+" will appear in the main display area to enter the

cumulative addition measurement mode. Then continue the measurement, and the instrument will automatically cumulative addition.

In the accumulative mode, short-press the  button again. The "-" icon will appear in the main display area to enter the cumulative subtraction measurement mode. Then continue the measurement, and the instrument will automatically cumulative subtraction.

## 2. Area, Volume in cumulative addition and subtraction

The Volume accumulated addition and subtraction operations are the same as Area accumulated addition and subtraction. Here is the sample for Area accumulated addition and subtraction:



figure ①

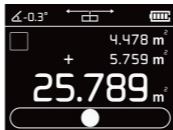

figure ②

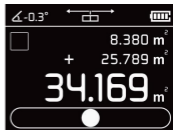





figure ③

Step 1, measure the area once (as shown in figure ①).

Step 2, short press the  button, "+" will appear in the main display area, enter the cumulative addition measurement mode, and then measure the second area (as shown in figure ②).





Step 3, short press the  button, and the device will automatically calculate the sum of the two areas (as shown in figure ③).

Volume cumulative addition and subtraction: In step 1, short press the  button to enter the accumulation, then short press the  button switch to cumulative subtraction mode. the subsequent operations are similar to cumulative addition and will not be described again.



Multiple cumulative addition/subtraction operations:

In step 2, after obtaining the area for the second time, short press the  button again. You can continue to cumulative addition/subtraction for the next area. Finally, follow step 3 to obtain a result.

## Recording

- After the instrument measurement is completed, the result will be automatically stored.
- Long press the  button to view the records; short press the  or  button to look back at the records; Long press the  button to clear all records.

## Charging

- The device displays , indicating that the battery is insufficient. Reminds the user should charge it immediately to avoid affecting the accuracy of measurement.
- Please use a compliant charger with DC5V  $\geq$  1A output for charging, and it is recommended to use a mobile phone charger.
- Charging indication: The instrument scrolls to display , indicating that it is not fully charged. When it displays , and no longer scrolling, it means full.
- Battery maintenance: If you don't use it for a such long time, it is recommended to fully charge the device first, and recharge it every six months to avoid discharge damage in the battery.

# Prompt information

During use, the following prompt information may appear in the main display area:

Signal	Reason	Solution
Err	Out of measure range	Let the instrument work in an effective measurement range
Err1	Signal is too weak ( <b>black wall, over working distance</b> )	To measure highly reflective target points (a <b>light color wall</b> or <b>target</b> )
Err2	Signal is too strong ( <b>Indoor smooth surfaces (tiles, smooth painted surfaces, etc)</b> )	To measure weakly reflective target points (a <b>light color wall</b> or <b>target</b> )
Err3	Battery voltage is too low	charge the battery
Err4	Out of operating temperature range	Let the instrument be used in the specified environment
Err5	Pythagorean Measurement Violations	Re-measure to make sure the hypotenuse is larger than the right-angle side
Err6	Angle sensor error	Return to factory for repair

# Device Routine Maintenance

- It is forbidden to store the instrument in a high-temperature and high-humidity environment for a long time. When the instrument is not used for a long time, please place the instrument in the random instrument case and store it in a cool and dry place.
- Please keep the surface of the instrument clean, wipe the surface dust with a damp soft cloth, and do not clean the instrument with corrosive lotions. The laser window and focusing mirror can be cleaned in the same way as the optics table.
- In harsh environments such as: 1. the sunlight is too strong, 2. the ambient temperature fluctuates too much, 3. the effect of the reflective surface is weak, 4. the battery is insufficient. The accuracy will be affected by these environments. It is better to use the target reflector in this case.

# Technical Parameters

Function	Description
Maximum measure distance	60m (one-way) /120m (bilateral)
Minimum measure distance	0.05m
Measurement accuracy	$\pm(2\text{mm}+d*1/10000)$ * (one-way)
Inclination measure range	$\pm 90^\circ$
Continuous measurement	✓
Area and volume measurement	✓
Wall area measurement	✓
Pythagorean measurement	✓
Angle and altimetry measurement	✓
Length addition and subtraction	✓
Max / Min display	✓
Electronic level bubble	✓
Auto switch screen	✓
Magnetic attraction	✓
Laser class	II
Laser type	630-670nm. <1mW
Automatic cut-off laser	20 seconds
Automatic shut-down	180 seconds
Backlight time	60 seconds
Power supply	3.7V 850mAh lithium battery
Charging port	DC5V 0.75A Type-C
Working time	One-way: 12000 times; two-way: 8000 times
Storage temperature	-20°C~60°C
Working temperature	0°C~40°C
Storage humidity	20%~80%RH
Dimensions	115*50*24.5mm

\* "d" indicates the actual distance

# Sicherheitshinweise

 Lesen Sie vor dem ersten Gebrauch des Geräts die Sicherheitshinweise und die Bedienungsanleitung sorgfältig durch.

 Die Verwendung des Geräts, die nicht der in dieser Bedienungsanleitung beschriebenen Betriebsmethode entspricht, kann das Gerät beschädigen, die Messgenauigkeit beeinträchtigen und zu Verletzungen des Benutzers oder Dritten führen.

 Zerlegen oder reparieren Sie das Gerät auf keinen Fall selbst. Es ist strengstens verboten, die Leistung des Lasersenders des Geräts illegal zu modifizieren oder zu verändern. Bitte bewahren Sie das Gerät ordnungsgemäß auf, platzieren Sie es nicht an einem Ort, an dem Kinder es erreichen können, und vermeiden Sie die Verwendung durch unbeteiligte Personen.

 Es ist strengstens verboten, die Augen und andere Körperteile von sich selbst oder anderen mit dem Laser des Geräts zu bestrahlen, und es ist strengstens verboten, den Laser auf die Oberfläche von stark reflektierenden Objekten zu strahlen.

 Die elektromagnetische Strahlung des Geräts kann Interferenzen mit anderen Geräten verursachen. Bitte verwenden Sie das Gerät nicht in der Nähe von Flugzeugen oder medizinischen Geräten und nicht in brennbaren oder explosiven Umgebungen.

 Ausrangierte Geräte können nicht zusammen mit dem Hausmüll entsorgt werden. Bitte entsorgen Sie ausgediente Geräte gemäß den entsprechenden nationalen oder lokalen Gesetzen und Vorschriften.

# Produktübersicht

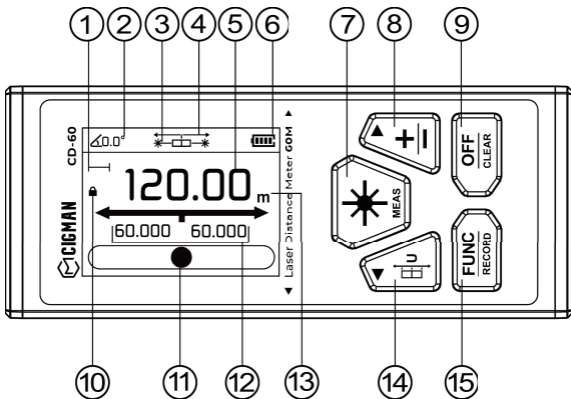



① Messmodus	② Winkelanzeige	③ Laseranzeige
④ Bezugsebene der Messung	⑤ Display	⑥ Batterieanzeige
⑦ Einschalt-/ Messtaste	⑧ Plus-/Minus-Taste/ Sperrtaste	⑨ Aus-/Löschen-Taste
⑩ Sperranzeige	⑪ Blase	⑫ Hilfsanzeige
⑬ Einheitenanzeige	⑭ Umschalttaste Einheit/Bezugsebene	⑮ Funktionsschalter-/ Aufzeichnungstaste



# Grundfunktion

## ● Ein-/ Ausschalten

Drücken Sie im ausgeschalteten Zustand lange auf die Taste . Das Gerät startet und wechselt in den Standby-Modus.

Drücken Sie im laufenden Zustand lange auf die Taste , um das Gerät auszuschalten. Erfolgt innerhalb von 180 Sekunden keine Bedienung, wird das Gerät automatisch geschlossen.

## ● Einheiteneinstellung

Drücken Sie im Standby-Modus lange auf die Taste , um die Einheit umzuschalten. Das Gerät bietet 6 Auswahlmöglichkeiten.

Einheit	Länge	Bereich	Volumen
1	0.000 m	0.000 m <sup>2</sup>	0.000 m <sup>3</sup>
2	0.00 m	0.00 m <sup>2</sup>	0.00 m <sup>3</sup>
3	0.0 in	0.00 ft <sup>2</sup>	0.00 ft <sup>3</sup>
4	0 $\frac{1}{16}$ in	0.00 ft <sup>2</sup>	0.00 ft <sup>3</sup>
5	0'00" $\frac{1}{16}$	0.00 ft <sup>2</sup>	0.00 ft <sup>3</sup>
6	0.00 ft	0.00 ft <sup>2</sup>	0.00 ft <sup>3</sup>

## ● Bezugsebene einstellen

Drücken Sie kurz die Taste  , um die Bezugsebene auszuwählen. Die Standardeinstellung ist die bilaterale Messung.

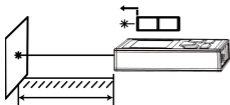

Bezugsebene vorne-links

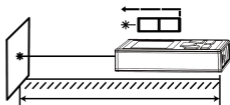

Bezugsebene hinten-links

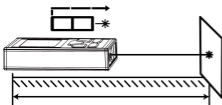

Bezugsebene hinten-rechts

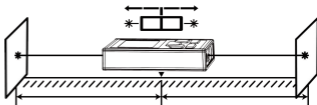

bilaterale Messung

## ● Auswahl des Messmodus

Drücken Sie kurz die Taste  , um zur Modusauswahl zu gelangen. Wird wie folgt angezeigt:



Drücken Sie kurz die Taste  oder  , um den Modus zu wechseln;



Drücken Sie kurz die Taste  , um den Modus auszuwählen;

Drücken Sie kurz die Taste  , um zurückzukehren.

Es gibt neun Messmodi im Gerät:

	Längenmessung		Winkel- und Höhenmessung
	Flächenmessung		Indirekte Höhenmessung
	Volumenmessung		Hypotenuse-Messung
	Messung der Wandfläche		Doppelte indirekte Höhenmessung
			Hilfshöhenmessung

## ● Bildschirm drehen und sperren

Das Gerät unterstützt die automatische Bildschirmdrehung, drücken Sie lange die Taste , um die Bildschirmausrichtung zu sperren, und der Bildschirm zeigt  an. Drücken Sie lange die Taste , um die Bildschirmausrichtungssperre aufzuheben.

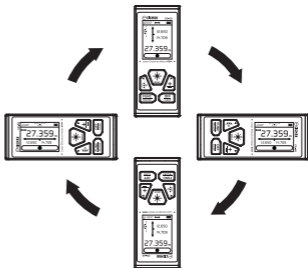

## ● Elektronische Wasserwaage

Das Gerät ist mit einer elektronischen Libelle ausgestattet, um das Niveau der Oberfläche zu messen.

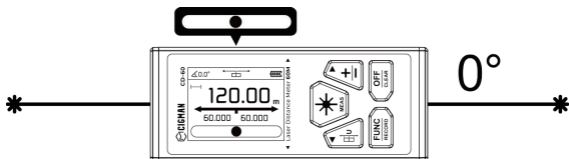

## ● Starke magnetische Adsorption

Auf der Rückseite des Geräts befindet sich ein Magnet, der die Oberfläche des Metalls adsorbieren kann.

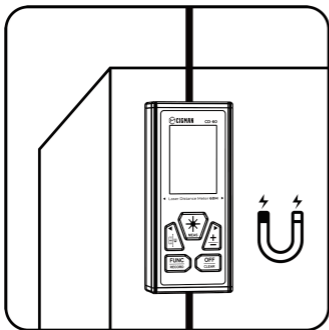

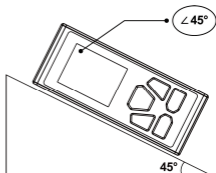
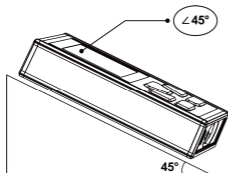

## ● Winkelmessung

Das Gerät verfügt über einen eingebauten Neigungssensor, der die Bodenneigung und die Seitenneigung in Echtzeit messen kann.







## Messfunktionen

### ● Längenmessung - Einzelmessung

Drücken Sie die Taste  unter der Längenmessung, das Gerät sendet einen Laserpunkt aus, um die Messposition zu lokalisieren. Drücken Sie dann erneut die Taste  für eine einzelne Entfernungsdatenmessung. Der Messwert wird im Hauptanzeigebereich angezeigt. Während der bilateralen Messung zeigt der Hilfsanzeigebereich die Entfernungen auf der linken bzw. rechten Seite an.

### ● Längenmessung - kontinuierliche Messung

Halten Sie in der Längenmessung die Taste  gedrückt, um in den kontinuierlichen Messzustand zu wechseln, und der Bildschirm zeigt Echtzeit-Messdaten, Maximal- und Minimalwerte an; Drücken Sie einmal kurz die Taste  oder , um die Messung anzuhalten, drücken Sie diese beiden Tasten erneut, um die kontinuierliche Messung zu beenden.

Mittelpunktsuche: Stellen Sie die Referenzebene auf bidirektional ein, drücken Sie lange die Taste , um die kontinuierliche Messung zu starten, und finden Sie den Mittelpunkt gemäß den folgenden Eingabeaufforderungen. (Bei Verwendung der bilateralen Messung kann es zu einem Fehler von 1 mm bei den linken und rechten Messwerten kommen).

Horizontale Bildschirmdarstellung:

1. Auf dem Bildschirm wird **【←】** angezeigt, bitte bewegen Sie es nach links.
2. Auf dem Bildschirm wird **【→】** angezeigt, bitte bewegen Sie es nach rechts.

Vertikale Bildschirmdarstellung:

1. Auf dem Bildschirm wird **【↑】** angezeigt, bitte bewegen Sie es nach oben.
2. Auf dem Bildschirm wird **【↓】** angezeigt, bitte bewegen Sie es nach unten.

Wenn auf dem Bildschirm **→|←** angezeigt wird, bedeutet dies, dass es sich derzeit in der Mitte befindet.

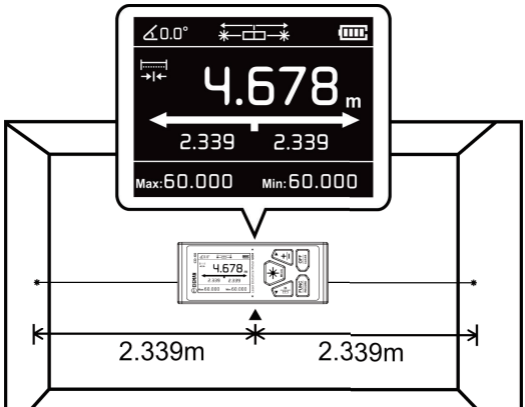

## ● Flächenmessung

Drücken Sie die Taste , um die erste Seite (Länge) zu messen.

Drücken Sie die Taste , um die zweite Seite (Breite) zu messen.

Das Gerät berechnet automatisch die Fläche und zeigt sie im Hauptanzeigebereich an.

Der Hilfsanzeigebereich zeigt die Längen- und Breitenmessungen an. Während der Messung können Sie auch die Taste  drücken, um den aktuellen Messwert zu löschen und erneut zu messen.

## ● Volumenmessung

1. Drücken Sie die Taste , um die erste Seite (Länge) zu messen.

2. Drücken Sie die Taste , um die zweite Seite (Breite) zu messen.

3. Drücken Sie die Taste , um die dritte Seite (Höhe) zu messen.

4. Das Gerät berechnet automatisch das Volumen und zeigt es im Hauptanzeigebereich an. Der Hilfsanzeigebereich zeigt die gemessenen Werte der Länge, Breite und Höhe des Würfels an.

Während der Messung können Sie auch die Taste  drücken, um den aktuellen Messwert zu löschen und erneut zu messen.

## ● Wandflächenmessung

1. Drücken Sie die Taste , um die Höhe der Wand zu messen;

2. Drücken Sie die Taste , um die Breite 1 von Wand 1 zu messen;

Das Gerät berechnet automatisch die Wandfläche = Höhe x Breite 1;

3. Drücken Sie die Taste , um die Breite 2 von Wand 2 zu messen;

Das Gerät berechnet automatisch die Summe der Wandfläche;

Flächensumme = Höhe x (Breite 1+Breite 2)

4. Drücken Sie analog die Taste , um die Breite n der Wand n zu messen;

Flächensumme = Höhe x (Breite 1+Breite 2+...+Breite n);

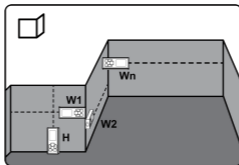

Während der Messung können Sie auch die Taste  drücken, um den aktuellen Messwert zu löschen und erneut zu messen.

## ● Indirekte Messung:

① Messen Sie den Winkel und die Höhe eines rechtwinkligen Dreiecks  (wie in Abbildung 1 gezeigt).

Drücken Sie die Taste  und folgen Sie den Anweisungen auf dem Bildschirm, um die Länge der Hypotenuse (**a**) zu messen.

Das Gerät kann gleichzeitig den Winkel zwischen der Hypotenuse und der Basisseite ( **$\theta$** ) messen.

Das Gerät kann den horizontalen Abstand (**b**) und die vertikale Höhe (**h**) automatisch berechnen.

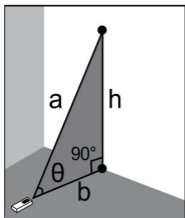

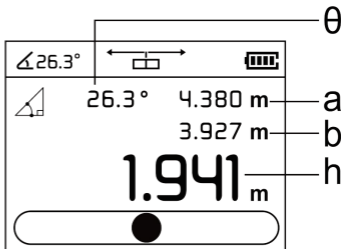

(Abbildung 1)



(Bildschirmanzeige)



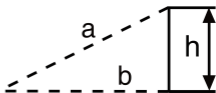

② Messen Sie die Höhe eines rechtwinkligen Dreiecks  (wie in Abbildung 2 gezeigt)

1. Drücken Sie die Taste  und folgen Sie den Anweisungen auf dem Bildschirm, um die Länge der Hypotenuse (**a**) zu messen.
2. Drücken Sie die Taste  und messen Sie dann die Länge der rechtwinkligen Seite (**b**).
3. Das Gerät berechnet nach der zweiten Messung automatisch die Höhe (**h**) des Dreiecks.



(Abbildung 2)

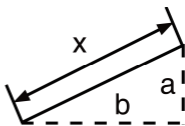

③ Messen Sie die Hypotenuse eines rechtwinkligen Dreiecks  (wie in Abbildung 3 gezeigt)

1. Drücken Sie die Taste , um die Länge einer Seite gemäß der Aufforderung auf dem Bildschirm zu messen (**a**).
2. Drücken Sie die Taste , um die Länge einer rechtwinkligen Kante (**b**) zu messen.
3. Das Gerät berechnet nach der zweiten Messung automatisch die Hypotenuse (**x**) des Dreiecks.



(Abbildung 3)

④ Messen Sie die doppelte indirekte Höhe eines gleichschenkligen Dreiecks  (wie in Abbildung 4 gezeigt).

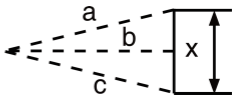

1. Drücken Sie die Taste  und befolgen Sie die Anweisungen auf dem Bildschirm, um die Länge einer Hypotenuse (**a**) zu messen.
2. Drücken Sie die Taste  und messen Sie dann die Länge der rechtwinkligen Kante (**b**).
3. Drücken Sie die Taste , um die Länge der anderen Hypotenuse (**c**) zu messen.
4. Nach der Messung berechnet das Gerät automatisch die Höhe des Dreiecks (**x**).



(Abbildung 4)

⑤ Messen Sie die Hilfshöhe des Dreiecks



1. Drücken Sie die Taste  und befolgen Sie die Anweisungen auf dem Bildschirm, um die Länge einer Hypotenuse (**a**) zu messen.
2. Drücken Sie die Taste , um die Länge der anderen Seite (**b**) zu messen.
3. Drücken Sie die Taste , um die Länge einer anderen Hypotenuse (**c**) zu messen.
4. Nach der Messung berechnet das Gerät automatisch die Hilfshöhe (**x**) des Dreiecks.

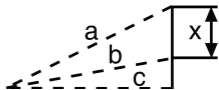

(Abbildung 5)

### Hinweis:

Im Pythagoräischen Messmodus kann das Gerät nur die Länge der rechtwinkligen Seite berechnen, die kleiner als die Hypotenuse sein muss. Andernfalls zeigt das Gerät ein Fehlersignal an.

Im pythagoräischen Messmodus muss zur Gewährleistung der Genauigkeit vom gleichen Startpunkt aus und in der Reihenfolge Hypotenuse und rechter Winkel gemessen werden.

## ● Additions- und Subtraktionsmessung:

1. Kumulierte Addition und Subtraktion der Länge



Messen Sie in der Längenmessung einen Datensatz.

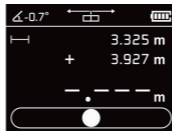

Drücken Sie kurz die Taste , um den kumulativen Modus aufzurufen.



Messen Sie dann die Daten, das Gerät wird automatisch akkumulieren und summieren.

Drücken Sie kurz die Taste , „+“ erscheint im Hauptanzeigebereich, um den kumulativen Additionsmessmodus aufzurufen. Setzen Sie dann die Messung fort, und

das Gerät führt automatisch eine kumulative Addition durch.

Drücken Sie im kumulativen Modus erneut kurz die Taste . Das Symbol „-“ erscheint im Hauptanzeigebereich, um in den kumulativen Subtraktionsmessmodus zu gelangen. Setzen Sie dann die Messung fort, und das Gerät führt automatisch eine kumulative Subtraktion durch.

## 2. Fläche, Volumen in kumulativer Addition und Subtraktion

Die volumenakkumulierten Additions- und Subtraktionsoperationen sind die gleichen wie die flächenakkumulierte Addition und Subtraktion. Hier ist das Beispiel für flächenakkumulierte Addition und Subtraktion:



Abbildung ①



Abbildung ②





Abbildung ③

Schritt 1: Messen Sie die Fläche einmal (wie in Abbildung ① gezeigt).

Schritt 2, drücken Sie kurz die Taste , „+“ erscheint im Hauptanzeigebereich, rufen Sie den kumulativen Additionsmessmodus auf und messen Sie dann den zweiten Bereich (wie in Abbildung ② gezeigt).





Schritt 3, drücken Sie kurz die Taste , und das Gerät berechnet automatisch die Summe der beiden Bereiche (wie in Abbildung ③ gezeigt).

Kumulative Addition und Subtraktion des Volumens: Drücken Sie in Schritt 1 kurz die Taste , um die Akkumulation aufzurufen, und drücken Sie dann kurz die Taste , um in den kumulativen Subtraktionsmodus zu wechseln. Die nachfolgenden Operationen ähneln der kumulativen Addition und werden nicht erneut beschrieben.



Mehrere kumulative Additions-/Subtraktionsoperationen:

Drücken Sie in Schritt 2 nach dem zweiten Abrufen des Bereichs erneut kurz die Taste . Sie können mit der kumulativen Addition/Subtraktion für den nächsten Bereich fortfahren. Befolgen Sie schließlich Schritt 3, um ein Ergebnis zu erhalten.

# Aufzeichnung

- Nach Abschluss der Gerätemessung wird das Ergebnis automatisch gespeichert;
- Drücken Sie lange die Taste , um die Aufzeichnungen anzuzeigen; Drücken Sie kurz die Taste  oder , um sich die Aufzeichnungen anzusehen; Drücken Sie lange die Taste , um alle Aufzeichnungen zu löschen.

# Aufladung

- Das Gerät zeigt  an, was darauf hinweist, dass der Akku nicht ausreicht. Erinnert den Benutzer daran, es sofort aufzuladen, um eine Beeinträchtigung der Messgenauigkeit zu vermeiden.
- Bitte verwenden Sie zum Aufladen ein kompatibles Ladegerät mit DC5V  $\geq$  1A Ausgang, und es wird empfohlen, ein Ladegerät für Mobiltelefone zu verwenden.
- Ladeanzeige: Das Gerät scrollt zu Anzeige  und zeigt damit an, dass es nicht vollständig aufgeladen ist. Wenn es  anzeigt und nicht mehr scrollt, bedeutet es voll.
- Batteriewartung: Wenn Sie es so lange nicht benutzen, wird empfohlen, das Gerät zuerst vollständig aufzuladen und alle sechs Monate nachzuladen, um Entladungsschäden an der Batterie zu vermeiden.

# Fehlermeldung

Während der Verwendung können folgende Fehlermeldungen erscheinen:

Signal	Grund	Lösung
Err	Außerhalb des Messbereichs	Lassen Sie das Gerät in einem effektiven Messbereich arbeiten
Err1	Signal ist zu schwach <b>(schwarze Wand, über Arbeitsabstand)</b>	So messen Sie stark reflektierende Zielpunkte <b>(eine helle Wand oder ein Ziel)</b>
Err2	Das Signal ist zu stark <b>(glatte Innenflächen (Fliesen, glatte lackierte Oberflächen usw.))</b>	Zum Messen von schwach reflektierenden Zielpunkten <b>(helle Wand oder Ziel)</b>
Err3	Niedriger Batteriestatus	Bitte aufladen.
Err4	Außerhalb des Betriebstemperaturbereichs	Lassen Sie das Gerät in der angegebenen Umgebung verwenden.
Err5	Verstöße gegen Pythagoräische Messungen	Messen Sie erneut, um sicherzustellen, dass die Hypotenuse größer als die rechteckige Seite ist
Err6	Winkelsensorfehler	Zur Reparatur ins Werk zurücksenden

# Rutinewartung des Geräts

- Es ist verboten, das Gerät für längere Zeit in einer Umgebung mit hoher Temperatur und Luftfeuchtigkeit zu lagern. Wenn das Gerät längere Zeit nicht benutzt wird, legen Sie das Gerät bitte in den mitgelieferten Gerätekofter und lagern Sie es an einem kühlen und trockenen Ort.
- Bitte halten Sie die Oberfläche des Geräts sauber, wischen Sie den Oberflächenstaub mit einem feuchten, weichen Tuch ab und reinigen Sie das Gerät nicht mit ätzenden Lotionen. Das Laserfenster und der Fokussierspiegel können auf die gleiche Weise wie der Optiktisch gereinigt werden.
- In rauen Umgebungen wie: 1. die Sonneneinstrahlung ist zu stark, 2. die Umgebungstemperatur schwankt zu stark, 3. die Wirkung der reflektierenden Oberfläche ist schwach, 4. die Batterie ist unzureichend. Die Genauigkeit wird durch diese Umgebungen beeinträchtigt. Verwenden Sie in diesem Fall besser den Zielreflektor.

# Technische Daten

Funktion	Beschreibung
Maximaler Messabstand	60m (einweg) 120m (bilateral)
Mindestmessabstand	0.05m
Meßgenauigkeit	$\pm(2\text{mm}+d^*1/10000)^*$ (Einweg)
Neigungsmessbereich	$\pm 90^\circ$
Kontinuierliche Messung	✓
Flächen- und Volumenmessung	✓
Messung der Wandfläche	✓
Pythagoreische Messung	✓
Winkel- und Höhenmessung	✓
Längenaddition und -subtraktion	✓
Max / Min-Anzeige	✓
Elektronische Wasserwaage	✓
Automatische drehung des Bildschirms	✓
Magnetische Anziehung	✓
Laserklasse	II
Lasertyp	630-670nm, <1mW
Automatische Laserabschaltung	20 Sekunden
Automatische Abschaltung	180 Sekunden
Zeit der Hintergrundbeleuchtung	60 Sekunden
Stromversorgung	3,7V 850mAh Lithium Batterie
Aufladestation	DC5V 0,75A Type-C
Arbeitszeit	Einweg: 12000 mal; bilateral: 8000 mal
Lagertemperatur	-20°C~60°C
Arbeitstemperatur	0°C~40°C
Luftfeuchtigkeit bei Lagerung	20%~80%RH
Maße	115*50*24,5mm

\* „d“ zeigt die tatsächliche Distanz an.

# Règles de sécurité

 Avant d'utiliser l'appareil pour la première fois, lisez attentivement les consignes de sécurité et le mode d'emploi.

 L'utilisation de l'appareil non conforme à la méthode de fonctionnement décrite dans ce manuel peut endommager l'appareil, affecter la précision de la mesure et entraîner des blessures pour l'utilisateur ou des tiers.

 Ne démontez ou ne réparez en aucun cas l'appareil par vous-même. Il est strictement interdit de modifier ou d'altérer illégalement les performances de l'émetteur laser de l'appareil. Veuillez stocker l'appareil correctement, ne le placez pas dans un endroit où les enfants peuvent atteindre et évitez l'utilisation par des passants.

 Il est strictement interdit d'irradier les yeux et d'autres parties du corps de vous-même ou d'autres personnes avec le laser de la machine, et il est strictement interdit d'irradier le laser sur la surface d'objets hautement réfléchissants.

 Le rayonnement électromagnétique de l'appareil peut provoquer des interférences avec d'autres appareils. Veuillez ne pas utiliser l'appareil à proximité d'avions ou d'équipements médicaux, et ne pas l'utiliser dans des environnements inflammables ou explosifs.

 Les appareils mis au rebut ne peuvent pas être jetés avec les ordures ménagères. Veuillez éliminer les appareils en fin de vie conformément aux lois et réglementations nationales ou locales en vigueur.

# Caractéristiques

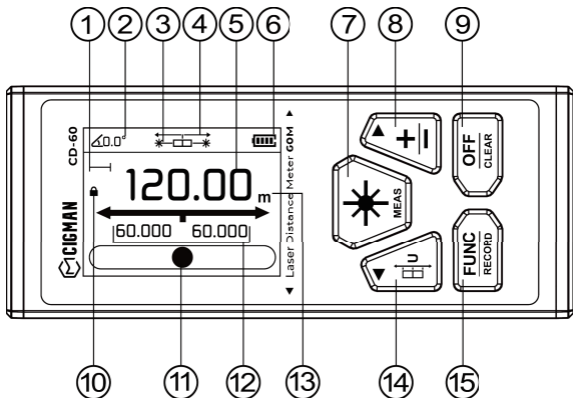



① Mode de mesure	② Indicateur d'angle	③ Indicateur laser
④ Plan de référence	⑤ Écran	⑥ indicateur de batterie
⑦ Allumer/ bouton de mesure	⑧ Touche plus et moins/ touche de verrouillage	⑨ Bouton d'Éteindre/Effacer
⑩ indicateur de verrouillage	⑪ Bulle de niveau	⑫ Zone d'affichage auxiliaire
⑬ Affichage de l'unité	⑭ Bascule Unité/ Plan de référence	⑮ Bouton de commutateur de fonction/enregistrement



# Fonction basique

## ● Allumer / éteindre

Dans l'état d'arrêt, appuyez longuement sur le bouton  . L'appareil démarre et se met en veille.

Dans l'état de fonctionnement, appuyez longuement sur le bouton  pour éteindre l'appareil. S'il n'y a aucune opération dans les 180 secondes, l'appareil se fermera automatiquement.

## ● Réglage de l'unité

En mode veille, appuyez longuement sur le bouton  pour changer l'unité. L'appareil propose 6 choix.

Unité	Longueur	Zone	Volume
1	0.000 m	0.000 m <sup>2</sup>	0.000 m <sup>3</sup>
2	0.00 m	0.00 m <sup>2</sup>	0.00 m <sup>3</sup>
3	0.0 in	0.00 ft <sup>2</sup>	0.00 ft <sup>3</sup>
4	0 $\frac{1}{16}$ in	0.00 ft <sup>2</sup>	0.00 ft <sup>3</sup>
5	0'00" $\frac{1}{16}$	0.00 ft <sup>2</sup>	0.00 ft <sup>3</sup>
6	0.00 ft	0.00 ft <sup>2</sup>	0.00 ft <sup>3</sup>

## ● Définir le plan de référence

Appuyez brièvement sur le bouton  pour sélectionner le plan de référence. La valeur par défaut est la mesure bilatérale.

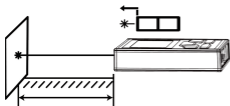

Plan de référence avant-gauche

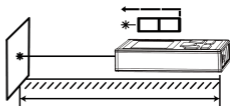

Plan de référence arrière-gauche

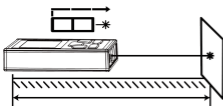

Plan de référence arrière droit

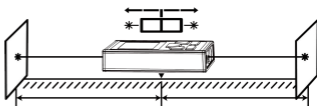

mesure bilatérale

## ● Sélection du mode de mesure

Appuyez brièvement sur le bouton  pour accéder à la sélection du mode.

Apparaît comme suit:











Appuyez brièvement sur le bouton  ou  pour changer de mode;



Appuyez brièvement sur le bouton  pour sélectionner le mode;

Appuyez brièvement sur le bouton  pour revenir.

Il existe neuf modes de mesure dans l'appareil:

	Mesure de longueur		Mesure d'angle et de hauteur
	Mesure de surface		Mesure de hauteur indirecte
	Mesure des volumes		Mesure de l'hypoténuse
	Mesure de la surface du mur		Double mesure indirecte de la hauteur
			Mesure de hauteur auxiliaire

## ● Faire pivoter et verrouiller l'écran

L'appareil prend en charge la rotation automatique de l'écran, appuyez longuement sur le bouton  pour verrouiller l'orientation de l'écran et l'écran affiche . Appuyez longuement sur la touche  pour annuler le verrouillage de l'orientation de l'écran.

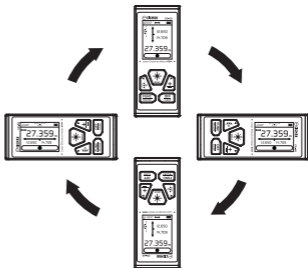

## ● Niveau à bulle électronique

L'appareil est équipé d'un niveau électronique pour mesurer le niveau de la surface.

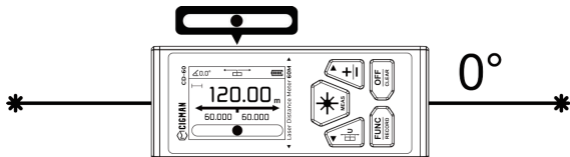

## ● Forte adsorption magnétique

Il y a un aimant à l'arrière de l'outil, qui peut adsorber la surface du métal.

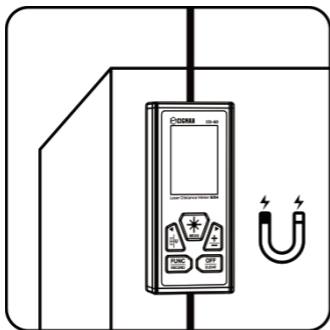

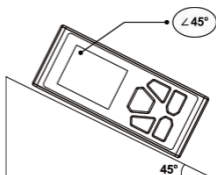
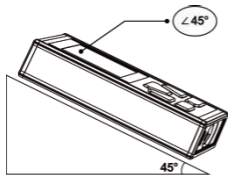

## ● Mesure d'angle

L'équipement dispose d'un capteur d'inclinaison intégré, qui peut mesurer l'inclinaison du fond et l'inclinaison latérale en temps réel.







## Fonctions de mesure

### ● Mesure de longueur - mesure unique :

Appuyez sur le bouton  sous la mesure de longueur, l'appareil émettra un point laser pour localiser la position de mesure. Appuyez ensuite à nouveau sur le bouton  pour une seule mesure de données de distance. La valeur mesurée est affichée dans la zone d'affichage principale. Pendant la mesure bilatérale, la zone d'affichage auxiliaire affiche les distances respectivement à gauche et à droite.

### ● Mesure de longueur - mesure continue :

Dans la mesure de la longueur, appuyez et maintenez la touche  pour entrer dans l'état de mesure continue, et l'écran affichera les données de mesure en temps réel, les valeurs maximales et minimales; Appuyez brièvement une fois sur le bouton  ou  pour mettre la mesure en pause, appuyez à nouveau sur ces deux boutons pour arrêter la mesure en continu.

Recherche du centre : Définissez le plan de référence sur bidirectionnel, appuyez longuement sur la touche  pour démarrer la mesure continue et recherchez le centre en fonction des invites suivantes. (Lorsque vous utilisez une mesure bilatérale, il peut y avoir une erreur de 1 mm dans les lectures gauche et droite).

Affichage horizontal de l'écran:

1. L'écran affiche  , veuillez le déplacer vers la gauche.
2. L'écran affiche  , veuillez le déplacer vers la droite.

Affichage vertical de l'écran:

1. L'écran affiche  , veuillez le déplacer vers le haut.
2. L'écran affiche  , veuillez le déplacer vers le bas.

Lorsque l'écran affiche  , cela signifie qu'il est actuellement au point médian.

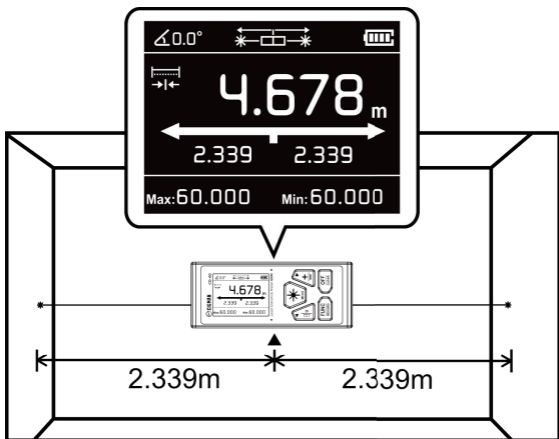

## ● Mesure de surface :

Appuyez sur le bouton  pour mesurer le premier côté (longueur).

Appuyez sur le bouton  pour mesurer le deuxième côté (largeur).

L'appareil calculera automatiquement la zone et l'affichera dans la zone d'affichage principale. La zone d'affichage auxiliaire affiche les mesures de longueur et de largeur.

Pendant la mesure, vous pouvez également appuyer sur le bouton  pour effacer la lecture actuelle et remesurer.

## ● Mesure volumique :

1. Appuyez sur le bouton  pour mesurer le premier côté (longueur)

2. Appuyez sur le bouton  pour mesurer le deuxième côté (largeur)

3. Appuyez sur le bouton  pour mesurer le troisième côté (hauteur)

4. L'appareil calculera automatiquement le volume et l'affichera dans la zone d'affichage principale. La zone d'affichage auxiliaire affiche les valeurs mesurées de la longueur, de la largeur et de la hauteur du cube.

Pendant la mesure, vous pouvez également appuyer sur le bouton  pour effacer la lecture actuelle et remesurer.

## ● Mesure de la surface du mur :

1. Appuyez sur le bouton  pour mesurer la hauteur du mur;

2. Appuyez sur le bouton  pour mesurer la largeur 1 du mur 1;

L'appareil calculera automatiquement la surface du mur = hauteur x largeur 1;

3. Appuyez sur le bouton  pour mesurer la largeur 2 du mur 2;

L'appareil calculera automatiquement la somme de la surface du mur;

Somme de la surface = hauteur x (largeur 1+largeur 2);

4. Par analogie, appuyez sur le bouton  pour mesurer la largeur n du mur n;

Somme de surface = hauteur x (largeur 1+largeur 2+...+largeur n);

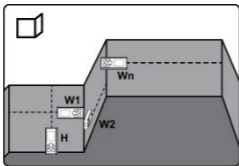

Pendant la mesure, vous pouvez également appuyer sur le bouton  pour effacer la lecture actuelle et remesurer.

## ● Mesure indirecte:

① Mesurer l'angle et la hauteur d'un triangle rectangle  (comme indiqué sur la figure 1)

Appuyez sur le bouton  et suivez les instructions à l'écran pour mesurer la longueur de l'hypoténuse (**a**).

L'appareil peut mesurer simultanément l'angle entre l'hypoténuse et le côté base ( **$\theta$** ).

L'appareil peut calculer automatiquement la distance horizontale (**b**) et la hauteur verticale (**h**).

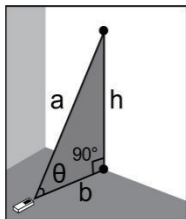

(figure 1)

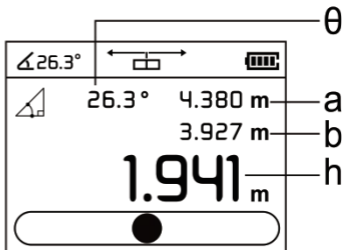



(écran d'affichage)



② Mesurer la hauteur d'un triangle rectangle

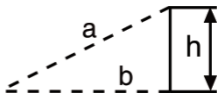

 (comme indiqué sur la figure 2).

1. Appuyez sur le bouton  et suivez les invites à l'écran pour mesurer la longueur de l'hypoténuse (**a**).
2. Appuyez sur le bouton , puis mesurez la longueur du côté à angle droit (**b**).
3. L'appareil calculera automatiquement la hauteur (**h**) du triangle après la deuxième mesure.



(figure 2)

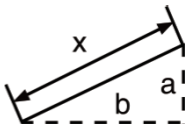

③ Mesurer l'hypoténuse d'un triangle rectangle  (comme illustré à la figure 3).

1. Appuyez sur le bouton  pour mesurer la longueur d'un côté selon l'invite à l'écran (**a**).
2. Appuyez sur le bouton  pour mesurer la longueur d'un bord à angle droit (**b**).
3. L'appareil calculera automatiquement l'hypoténuse (**x**) du triangle après la deuxième mesure.



(figure 3)

④ Mesurez la double hauteur indirecte d'un triangle isocèle  (comme illustré à la figure 4).

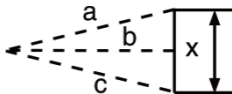

1. Appuyez sur le bouton  et suivez les invites à l'écran pour mesurer la longueur d'une hypoténuse (**a**).
2. Appuyez sur le bouton , puis mesurez la longueur du bord à angle droit (**b**).
3. Appuyez sur le bouton  pour mesurer la longueur de l'autre hypoténuse (**c**).
4. Après la mesure, l'appareil calcule automatiquement la hauteur du triangle (**x**).

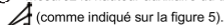

(figure 4)

⑤ Mesurez la hauteur auxiliaire du triangle



1. Appuyez sur le bouton  et suivez les instructions à l'écran pour mesurer la longueur d'une hypoténuse **(a)**.
2. Appuyez sur le bouton  pour mesurer la longueur de l'autre côté **(b)**.
3. Appuyez sur le bouton  pour mesurer la longueur d'une autre hypoténuse **(c)**.
4. Après la mesure, l'appareil calcule automatiquement la hauteur auxiliaire **(X)** du triangle.

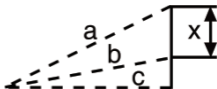

(figure 5)

### Avis:

En mode de mesure de Pythagore, l'appareil ne peut calculer que la longueur du côté à angle droit qui doit être inférieure à l'hypoténuse. Sinon, l'appareil affichera un signal d'erreur.

Dans le mode de mesure de Pythagore, afin d'assurer la précision, il doit être mesuré à partir du même point de départ et mesuré dans l'ordre de l'hypoténuse et de l'angle droit.

## ● Mesure d'addition et de soustraction:

1. Addition et soustraction cumulatives de longueur



Dans la mesure de la longueur, mesurez un record.

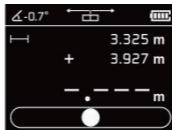

Appuyez brièvement sur le bouton  pour entrer dans le mode cumulatif.

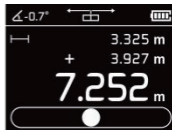

Ensuite, mesurez les données, l'appareil accumulera et additionnera automatiquement.

Appuyez brièvement sur le bouton , "+" apparaîtra dans la zone d'affichage

principale pour entrer dans le mode de mesure d'addition cumulative. Ensuite, continuez la mesure et l'appareil effectuera automatiquement l'addition cumulative. En mode cumulatif, appuyez à nouveau brièvement sur le bouton . L'icône "-" apparaîtra dans la zone d'affichage principale pour entrer dans le mode de mesure de soustraction cumulative. Continuez ensuite la mesure et l'appareil effectuera automatiquement la soustraction cumulative.

## 2. Aire, Volume en addition et soustraction cumulatives

Les opérations d'addition et de soustraction de volume cumulé sont les mêmes que pour l'addition et la soustraction de surface cumulée. Voici l'exemple pour l'addition et la soustraction cumulées d'aire:

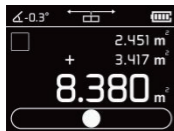

figure ①



figure ②



figure ③

Étape 1, mesurez la zone une fois (comme indiqué sur la figure ①).

Étape 2, appuyez brièvement sur le bouton , "+" apparaîtra dans la zone d'affichage principale, entrez dans le mode de mesure d'addition cumulative, puis mesurez la deuxième zone (comme indiqué sur la figure ②).





Étape 3, appuyez brièvement sur le bouton , et l'appareil calculera automatiquement la somme des deux zones (comme indiqué sur la figure ③).

Addition et soustraction cumulatives de volume: À l'étape 1, appuyez brièvement sur le bouton pour entrer dans l'accumulation, puis appuyez brièvement sur le bouton pour passer en mode de soustraction cumulative. Les opérations ultérieures sont similaires à l'addition cumulative et ne seront pas décrites à nouveau.



Multiplés opérations d'addition/soustraction cumulatives:

À l'étape 2, après avoir obtenu la zone pour la deuxième fois, appuyez à nouveau brièvement sur le bouton . Vous pouvez continuer l'addition/soustraction cumulative pour la zone suivante. Enfin, suivez l'étape 3 pour obtenir un résultat.

# Enregistrement

- Une fois la mesure de l'appareil terminée, le résultat sera automatiquement stocké;
- Appuyez longuement sur le bouton  pour afficher les enregistrements; appuyez brièvement sur le bouton  ou  pour consulter les enregistrements; Appuyez longuement sur le bouton  pour effacer tous les enregistrements.

# Recharge

- L'appareil affiche , indiquant que la batterie est insuffisante. Rappelle à l'utilisateur qu'il doit le charger immédiatement pour éviter d'affecter la précision de la mesure.
- Veuillez utiliser un chargeur conforme avec une sortie DC5V  $\geq$  1A pour la charge, et il est recommandé d'utiliser un chargeur de téléphone portable.
- Indication de charge: L'instrument défile jusqu'à l'affichage , indiquant qu'il n'est pas complètement chargé. Lorsqu'il affiche , et ne défile plus, cela signifie plein.
- Entretien de la batterie: si vous ne l'utilisez pas pendant une si longue période, il est recommandé de charger complètement l'appareil en premier et de le recharger tous les six mois pour éviter d'endommager la batterie.

# Message d'erreur

Lors de l'utilisation, les messages d'erreur suivants peuvent apparaître:

Signal	Raison	Solution
Err	Hors plage de mesure	Laisser l'appareil fonctionner dans une plage de mesure efficace
Err1	Le signal est trop faible ( <b>mur noir, dépassement de la distance de travail</b> )	Pour mesurer des points cibles hautement réfléchissants ( <b>un mur ou une cible de couleur claire</b> )
Err2	Le signal est trop fort ( <b>surfaces intérieures lisses (carrelage, surfaces peintes lisses, etc.)</b> )	Pour mesurer des points cibles faiblement réfléchissants ( <b>un mur ou une cible de couleur claire</b> )
Err3	Batterie faible	Veillez charger
Err4	Hors plage de température de fonctionnement	Laissez l'appareil être utilisé dans l'environnement spécifié.
Err5	Violations des mesures de Pythagore	Mesurez à nouveau pour vous assurer que l'hypoténuse est plus grande que le côté à angle droit
Err6	Erreur du capteur d'angle	Retour à l'usine pour réparation

# Maintenance de routine de l'appareil

- Il est interdit de stocker l'appareil dans un environnement à haute température et à forte humidité pendant une longue période. Lorsque l'appareil n'est pas utilisé pendant une longue période, placez-le dans le boîtier de l'appareil aléatoire et rangez-le dans un endroit frais et sec.
- Veuillez garder la surface de l'appareil propre, essuyez la poussière de surface avec un chiffon doux et humide et ne nettoyez pas l'appareil avec des lotions corrosives. La fenêtre laser et le miroir de focalisation peuvent être nettoyés de la même manière que la table optique.
- Dans des environnements difficiles tels que : 1. la lumière du soleil est trop forte, 2. la température ambiante fluctue trop, 3. l'effet de la surface réfléchissante est faible, 4. la batterie est insuffisante. La précision sera affectée par ces environnements. Il est préférable d'utiliser le réflecteur cible dans ce cas.

# Paramètres techniques

Fonction	Description
Distance de mesure maximale	60m (unidirectionnel) 120m (bilatéral)
Distance de mesure minimale	0.05m
Précision de mesure	$\pm(2\text{mm}+d*1/10000)^*$ (unidirectionnel)
Plage de mesure d'inclinaison	$\pm 90^\circ$
Mesure continue	✓
Mesure de surface et de volume	✓
Mesure de la surface du mur	✓
Mesure de Pythagore	✓
Mesure d'angle et d'altimétrie	✓
Ajout et soustraction de longueur	✓
Affichage Max / Min	✓
Niveau à bulle électronique	✓
Rotation de l'écran automatique	✓
Attraction magnétique	✓
Classe Laser	II
Type laser	630-670nm. <1mW
Arrêt automatique du laser	20 secondes
Arrêt automatique	180 secondes
Temps de rétro-éclairage	60 secondes
Source de courant	3,7V 850mAh batterie au lithium
Port de chargement	DC5V 0,75A Type-C
Temps de travail	unidirectionnel: 12000 fois; bilatéral: 8000 fois
Température de stockage	-20°C~60°C
Température de fonctionnement	0°C~40°C
Humidité de stockage	20%~80%HR
Dimensions	115*50*24,5mm

\* "d" indique la distance réelle

# Istruzioni di Sicurezza

 Prima di utilizzare il dispositivo per la prima volta, leggere attentamente le istruzioni di sicurezza e le istruzioni per l'uso.

 L'uso del dispositivo in contrasto con il metodo operativo descritto nel presente manuale può danneggiare il dispositivo, influire sulla precisione della misurazione e provocare lesioni all'utente o a terzi.

 Non smontare o riparare in nessun caso il dispositivo da soli. È severamente vietato modificare o alterare illegalmente le prestazioni del trasmettitore laser del dispositivo. Si prega di conservare il dispositivo correttamente, non collocarlo in un luogo dove i bambini possono raggiungere ed evitare l'uso da parte di astanti.

 È severamente vietato irradiare gli occhi e altre parti del corpo di se stessi o di altri con il laser della macchina ed è severamente vietato irradiare il laser sulla superficie di oggetti altamente riflettenti.

 La radiazione elettromagnetica del dispositivo può causare interferenze con altri dispositivi. Si prega di non utilizzare il dispositivo vicino ad aerei o apparecchiature mediche e non utilizzarlo in ambienti infiammabili o esplosivi.

 I dispositivi dismessi non possono essere smaltiti con i rifiuti domestici. Si prega di smaltire i dispositivi a fine vita in conformità con le leggi e i regolamenti nazionali o locali pertinenti.

# Panoramica del Prodotto

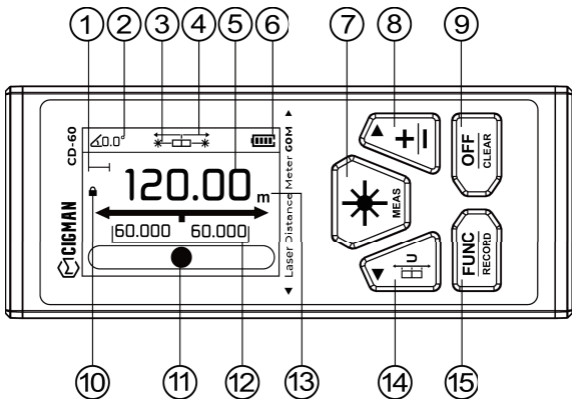



① Modalità di misura	② Indicatore di angolo	③ Indicatore laser
④ Piano di riferimento	⑤ Display	⑥ indicatore della batteria
⑦ Pulsante di accensione/misurazione	⑧ Tasto più e meno/tasto di blocco	⑨ Pulsante di spegnimento/cancellazione
⑩ indicatore di blocco	⑪ Bolla di livello	⑫ Area di visualizzazione ausiliaria
⑬ Visualizzazione dell'unità	⑭ Alterna Unità/Piano di riferimento	⑮ Pulsante di commutazione funzioni/registrazione



# Funzione di base

## ● Accensione/spegnimento

Nello stato di spegnimento, premere a lungo il pulsante . Il dispositivo si accende e passa alla modalità standby.

Nello stato di funzionamento, premere a lungo il pulsante  per spegnere il dispositivo. Se non viene eseguita alcuna operazione entro 180 secondi, il dispositivo verrà chiuso automaticamente.

## ● Impostazione dell'unità

In modalità standby, premere a lungo il pulsante  per cambiare unità. Il dispositivo offre 6 scelte.

Unità	Lunghezza	La zona	Volume
1	0.000 m	0.000 m <sup>2</sup>	0.000 m <sup>3</sup>
2	0.00 m	0.00 m <sup>2</sup>	0.00 m <sup>3</sup>
3	0.0 in	0.00 ft <sup>2</sup>	0.00 ft <sup>3</sup>
4	0 $\frac{1}{16}$ in	0.00 ft <sup>2</sup>	0.00 ft <sup>3</sup>
5	0'00" $\frac{1}{16}$	0.00 ft <sup>2</sup>	0.00 ft <sup>3</sup>
6	0.00 ft	0.00 ft <sup>2</sup>	0.00 ft <sup>3</sup>

## ● Imposta piano di riferimento

Premere brevemente il pulsante  per selezionare il piano di riferimento.  
L'impostazione predefinita è la misurazione bilaterale.

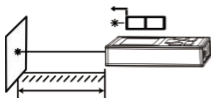

Piano di riferimento davanti a sinistra

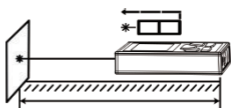

Piano di riferimento posteriore sinistro

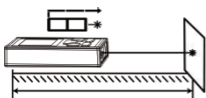

Piano di riferimento posteriore destro

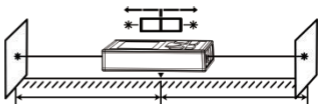

misurazione bilaterale

## ● Selezione della modalità di misurazione

Premere brevemente il pulsante  per accedere alla selezione della modalità.  
Appare come segue:





Premere brevemente il pulsante  o  per cambiare modalità;  
Premere brevemente il pulsante  per selezionare la modalità;  
Premere brevemente il pulsante  per tornare.

Ci sono nove modalità di misurazione nel dispositivo:

	Misura della lunghezza		Misura dell'angolo e dell'altezza
	Misurazione dell'area		Misura indiretta dell'altezza
	Misura del volume		Misura dell'ipotenusa
	Misura dell'area della parete		Doppia misurazione indiretta dell'altezza
			Misura dell'altezza ausiliaria

## ● Ruota e blocca lo schermo

Il dispositivo supporta la rotazione automatica dello schermo, premere a lungo il pulsante  per bloccare l'orientamento dello schermo e lo schermo visualizza . Premere a lungo il tasto  per annullare il blocco dell'orientamento dello schermo.

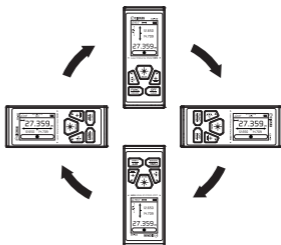

## ● Livella elettronica

Il dispositivo è dotato di una livella elettronica per misurare il livello della superficie.

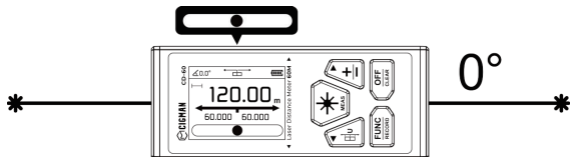

## ● Forte adsorbimento magnetico

C'è un magnete sul retro dello strumento, che può assorbire la superficie del metallo.

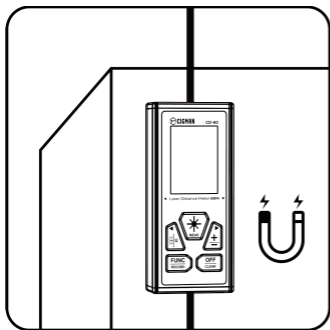

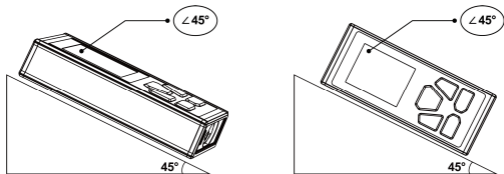

## ● Misura dell'angolo

L'attrezzatura ha un sensore di inclinazione integrato, che può misurare l'inclinazione del fondo e l'inclinazione laterale in tempo reale.







## Funzioni di misura

### ● Misura della lunghezza - Misura singola

Premere il pulsante  sotto la misurazione della lunghezza, il dispositivo emetterà un punto laser per individuare la posizione di misurazione. Quindi premere nuovamente il pulsante  per una singola misurazione dei dati di distanza. Il valore misurato viene visualizzato nell'area principale del display. Durante la misurazione bilaterale, l'area di visualizzazione ausiliaria mostra le distanze rispettivamente sul lato sinistro e destro.

### ● Misura della lunghezza - Misura continua

Nella misurazione della lunghezza, tenere premuto il tasto  per accedere allo stato di misurazione continua e lo schermo visualizzerà i dati di misurazione in tempo reale, i valori massimo e minimo; Premere brevemente il pulsante  o  una volta per mettere in pausa la misurazione, premere nuovamente questi due pulsanti per interrompere la misurazione continua.

Trova centro: impostare il piano di riferimento su bidirezionale, premere a lungo il tasto  per avviare la misurazione continua e trovare il centro in base alle seguenti istruzioni. (Quando si utilizza la misurazione bilaterale, potrebbe esserci un errore di 1 mm nelle letture sinistra e destra).

Visualizzazione dello schermo orizzontale:

1. Lo schermo mostra **【←】**, spostalo verso sinistra.
2. Lo schermo mostra **【→】**, spostarlo verso destra.

Visualizzazione dello schermo verticale:

1. Lo schermo mostra **【↑】**, spostalo verso l'alto.
2. Lo schermo mostra **【↓】**, spostalo verso il basso.

Quando lo schermo visualizza **→|←**, significa che è attualmente al punto medio.

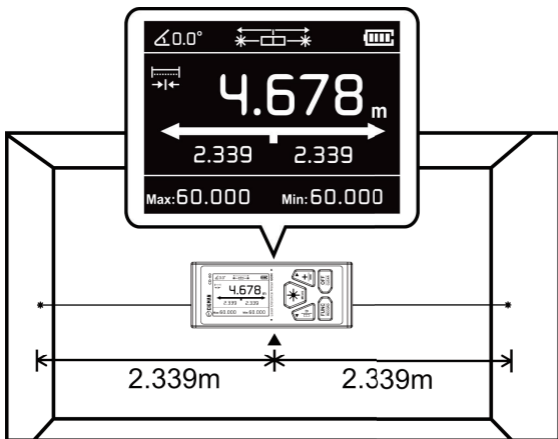

## ● Misurazione dell'area :

Premere il pulsante  per misurare il primo lato (lunghezza).

Premere il pulsante  per misurare il secondo lato (larghezza).

Il dispositivo calcolerà automaticamente l'area e la visualizzerà nell'area di visualizzazione principale. L'area di visualizzazione ausiliaria mostra le misure di lunghezza e larghezza. Durante la misurazione, è anche possibile premere il pulsante

 per cancellare la lettura corrente e ripetere la misurazione.

## ● Misurazione del volume :

1. Premere il pulsante  per misurare il primo lato (lunghezza).

2. Premere il pulsante  per misurare il secondo lato (larghezza).

3. Premere il pulsante  per misurare il terzo lato (altezza).

4. Il dispositivo calcolerà automaticamente il volume e lo visualizzerà nell'area di visualizzazione principale. L'area di visualizzazione ausiliaria mostra i valori misurati di lunghezza, larghezza e altezza del cubo.

Durante la misurazione, è anche possibile premere il pulsante  per cancellare la lettura corrente e ripetere la misurazione.

## ● Misurazione dell'area della parete :

1. Premere il pulsante  per misurare l'altezza del muro;

2. Premere il pulsante  per misurare la larghezza 1 della parete 1;

Il dispositivo calcolerà automaticamente l'area del muro =altezza x larghezza 1;

3. Premere il pulsante  per misurare la larghezza 2 della parete 2;

Il dispositivo calcolerà automaticamente la somma dell'area del muro;

Somma dell'area = altezza x (larghezza 1+larghezza 2);

4. Per analogia, premere il pulsante  per misurare la larghezza n della parete n;

Somma dell'area = altezza x (larghezza 1+larghezza 2+...+larghezza n);

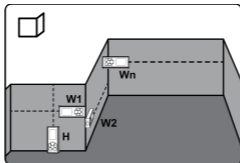

Durante la misurazione, è anche possibile premere il pulsante  per cancellare la lettura corrente e ripetere la misurazione.

## ● Misura indiretta:

① Misura l'angolo e l'altezza di un triangolo rettangolo  (come mostrato nella figura 1).

Premere il pulsante  e seguire le istruzioni sullo schermo per misurare la lunghezza dell'ipotenusa (**a**).

Il dispositivo può misurare contemporaneamente l'angolo tra l'ipotenusa e il lato base ( **$\theta$** ).

Il dispositivo può calcolare automaticamente la distanza orizzontale (**b**) e l'altezza verticale (**h**).

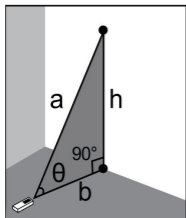

(figura 1)

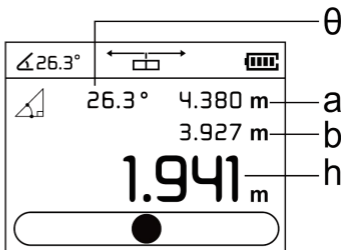



(visualizzazione dello schermo)



② Misura l'altezza di un triangolo rettangolo

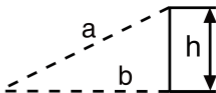

 (come mostrato nella figura 2).

1. Premere il pulsante  e seguire le istruzioni sullo schermo per misurare la lunghezza dell'ipotenusa (**a**).
2. Premere il pulsante , quindi misurare la lunghezza del lato ad angolo retto (**b**).
3. Il dispositivo calcolerà automaticamente l'altezza (**h**) del triangolo dopo la seconda misurazione.



(figura 2)



③ Misura l'ipotenusa di un triangolo rettangolo  (come mostrato nella figura 3).

1. Premere il pulsante  per misurare la lunghezza di un lato in base alla richiesta sullo schermo (**a**).
2. Premere il pulsante  per misurare la lunghezza di un bordo ad angolo retto (**b**).
3. Il dispositivo calcolerà automaticamente l'ipotenusa (**x**) del triangolo dopo la seconda misurazione.



(figura 3)

④ Misura la doppia altezza indiretta di un triangolo isoscele  (come mostrato in figura 4).

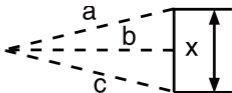

1. Premere il pulsante  e seguire le istruzioni sullo schermo per misurare la lunghezza di un'ipotenusa (**a**).
2. Premere il pulsante , quindi misurare la lunghezza del bordo ad angolo retto (**b**).
3. Premere il pulsante  per misurare la lunghezza dell'altra ipotenusa (**c**).
4. Dopo la misurazione, il dispositivo calcola automaticamente l'altezza del triangolo (**x**).



(figura 4)

⑤ Misurare l'altezza ausiliaria del triangolo

 (come mostrato nella figura 5).

1. Premere il pulsante  e seguire le istruzioni sullo schermo per misurare la lunghezza di un'ipotenusa (**a**).
2. Premere il pulsante  per misurare la lunghezza dell'altro lato (**b**).
3. Premere il pulsante  per misurare la lunghezza di un'altra ipotenusa (**c**).
4. Dopo la misurazione, il dispositivo calcolerà automaticamente l'altezza ausiliaria (**x**) del triangolo.

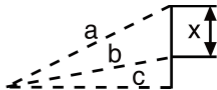

(figura 5)

### Avviso:

Nella modalità di misura pitagorica, il dispositivo può calcolare solo la lunghezza del lato rettangolo che deve essere minore dell'ipotenusa. In caso contrario, il dispositivo visualizzerà un segnale di errore.

Nella modalità di misurazione pitagorica, per garantire la precisione, deve essere misurata dallo stesso punto di partenza e misurata nell'ordine dell'ipotenusa e dell'angolo retto.

## ● Misurazione di addizione e sottrazione:

1. Lunghezza cumulativa addizione e sottrazione



Nella misurazione della lunghezza, misurare un record.

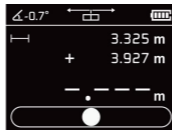

Premere brevemente il pulsante  per entrare in modalità cumulativa.



Quindi misurare i dati, il dispositivo si accumulerà e sommerà automaticamente.

Premere brevemente il pulsante , "+" apparirà nell'area di visualizzazione principale per accedere alla modalità di misurazione dell'addizione cumulativa. Quindi continuare

la misurazione e il dispositivo eseguirà automaticamente l'aggiunta cumulativa.

Nella modalità cumulativa, premere di nuovo brevemente il pulsante . L'icona "-" apparirà nell'area principale del display per accedere alla modalità di misurazione della sottrazione cumulativa. Quindi continuare la misurazione e il dispositivo eseguirà automaticamente la sottrazione cumulativa.

## 2. Area, Volume in addizioni e sottrazioni cumulative

Le operazioni di addizione e sottrazione del volume accumulato sono le stesse dell'addizione e della sottrazione dell'area accumulata. Ecco l'esempio per l'addizione e la sottrazione accumulate dall'area:



figura ①





figura ②





figura ③

Passaggio 1, misurare l'area una volta (come mostrato nella figura ①).

Passaggio 2, premere brevemente il pulsante , "+" apparirà nell'area del display principale, accedere alla modalità di misurazione dell'addizione cumulativa, quindi misurare la seconda area (come mostrato nella figura ②).





Passaggio 3, premere brevemente il pulsante  e il dispositivo calcolerà automaticamente la somma delle due aree (come mostrato nella figura ③).

Aggiunta e sottrazione cumulativa del volume: nel passaggio 1, premere brevemente il pulsante  per accedere all'accumulo, quindi premere brevemente il pulsante  per passare alla modalità di sottrazione cumulativa. le operazioni successive sono simili all'addizione cumulativa e non verranno descritte nuovamente.



Più operazioni di addizione/sottrazione cumulative:

Al passaggio 2, dopo aver ottenuto l'area per la seconda volta, premere di nuovo brevemente il pulsante . Puoi continuare con l'addizione/sottrazione cumulativa per l'area successiva. Infine, segui il passaggio 3 per ottenere un risultato.

# Registrazione

- Dopo che la misurazione del dispositivo è stata completata, il risultato verrà automaticamente memorizzato;
- Premere a lungo il pulsante  per visualizzare i record; premere brevemente il pulsante  o  per guardare indietro ai record; Premere a lungo il pulsante  per cancellare tutti i record.

# Ricarica

- Il dispositivo visualizza , a indicare che la batteria è insufficiente. Ricorda che l'utente dovrebbe ricaricarlo immediatamente per evitare di compromettere l'accuratezza della misurazione.
- Utilizzare un caricabatterie conforme con uscita DC5V  $\geq$  1A per la ricarica e si consiglia di utilizzare un caricabatterie per telefono cellulare.
- Indicazione di carica: lo strumento scorre fino a visualizzare , a indicare che non è completamente carico. Quando visualizza  e non scorre più, significa pieno.
- Manutenzione della batteria: se non lo si utilizza per un periodo di tempo così lungo, si consiglia di caricare prima completamente il dispositivo e ricaricarlo ogni sei mesi per evitare danni da scaricamento della batteria.

# Messaggio di errore

Durante l'uso, potrebbero apparire i seguenti messaggi di errore:

Segnale	Motivo	Soluzione
Err	Fuori portata di misura	Lascia che il dispositivo funzioni in un intervallo di misurazione effettivo
Err1	Il segnale è troppo debole <b>(muro nero, oltre la distanza di lavoro)</b>	Per misurare punti bersaglio altamente riflettenti <b>(una parete o un bersaglio di colore chiaro)</b>
Err2	Il segnale è troppo forte <b>(superfici lisce interne (piastrelle, superfici lisce verniciate, ecc.))</b>	Per misurare punti target debolmente riflettenti <b>(una parete o un target di colore chiaro)</b>
Err3	Batteria scarica	Si prega di caricare
Err4	Fuori dall'intervallo di temperatura di esercizio	Consentire al dispositivo di essere utilizzato nell'ambiente specificato.
Err5	Violazioni della misura pitagorica	Rimisura per assicurarti che l'ipotenusa sia maggiore dell'angolo retto
Err6	Errore del sensore angolare	Restituire alla fabbrica per la riparazione

## Manutenzione ordinaria del dispositivo

- È vietato conservare a lungo il dispositivo in un ambiente ad alta temperatura e alta umidità. Quando il dispositivo non viene utilizzato per un lungo periodo, inserire il dispositivo nella custodia del dispositivo casuale e conservarlo in un luogo fresco e asciutto.
- Si prega di mantenere pulita la superficie del dispositivo, pulire la polvere superficiale con un panno morbido umido e non pulire il dispositivo con lozioni corrosive. La finestra del laser e lo specchio di messa a fuoco possono essere puliti allo stesso modo del tavolo dell'ottica.
- In ambienti difficili come: 1. la luce solare è troppo forte, 2. la temperatura ambiente oscilla troppo, 3. l'effetto della superficie riflettente è debole, 4. la batteria è insufficiente. La precisione sarà influenzata da questi ambienti. In questo caso è meglio utilizzare il riflettore target.

# Parametri tecnici

Funzione	Descrizione
Distanza massima di misura	60m (unidirezionale) 120m (bilaterale)
Distanza minima di misura	0.05m
Accuratezza di misurazione	$\pm(2\text{mm}+d^*/10000)^*$ (unidirezionale)
Campo di misura dell'inclinazione	$\pm 90^\circ$
Misurazione continua	✓
Misurazione di aree e volumi	✓
Misura dell'area della parete	✓
Misura pitagorica	✓
Misura dell'angolo e dell'altimetria	✓
Addizioni e sottrazioni di lunghezza	✓
Visualizzazione massima/minima	✓
Bolla di livellamento elettronica	✓
Rotazione automatica dello schermo	✓
Attrazione magnetica	✓
Classe laser	II
Tipo laser	630-670nm. <1mW
Spegnimento automatico del laser	20 secondi
Spegnimento automatico	180 secondi
Tempo di retroilluminazione	60 secondi
Alimentazione elettrica	3,7V 850mAh batteria al litio
Porta di ricarica	DC5V 0,75A Type-C
Orario di lavoro	Unidirezionale: 12000 volte; bilaterale: 8000 volte
Temperatura di conservazione	-20°C~60°C
Temperatura di lavoro	0°C~40°C
Umidità di stoccaggio	20%~80%UR
Dimensioni	115*50*24,5mm

\* "d" indica la distanza effettiva

# Instrucciones de Seguridad

 Antes de usar el dispositivo por primera vez, lea atentamente las instrucciones de seguridad y las instrucciones de funcionamiento.

 El uso del dispositivo que no concuerde con el método operativo descrito en este manual puede dañar el dispositivo, afectar la precisión de la medición y provocar lesiones al usuario o a terceros.

 En ningún caso desmonte o repare el dispositivo usted mismo. Está estrictamente prohibido modificar o alterar ilegalmente el rendimiento del transmisor láser del dispositivo. Guarde el dispositivo correctamente, no lo coloque en un lugar donde los niños puedan alcanzarlo y evite que los transeúntes lo usen.

 Está estrictamente prohibido irradiar los ojos y otras partes del cuerpo de usted mismo o de otros con el láser de la máquina, y está estrictamente prohibido irradiar el láser en la superficie de objetos altamente reflectantes.

 La radiación electromagnética del dispositivo puede causar interferencias con otros dispositivos. No utilice el dispositivo cerca de aviones o equipos médicos, y no lo utilice en entornos inflamables o explosivos.

 Los dispositivos desechados no se pueden desechar con la basura doméstica. Deseche los dispositivos al final de su vida útil de acuerdo con las leyes y regulaciones nacionales o locales pertinentes.

# Características del producto

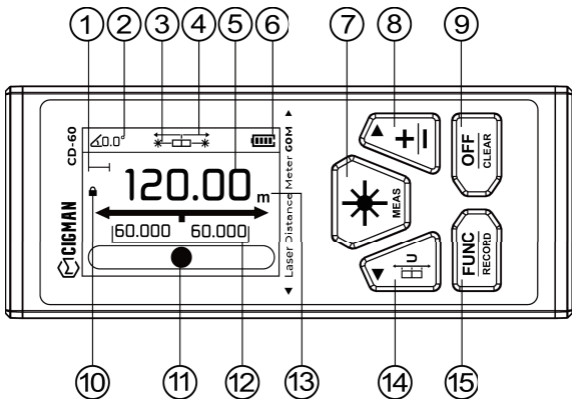



① Modo de medición	② Indicador de ángulo	③ Indicador de láser
④ Plano de nivel	⑤ Pantalla	⑥ indicador de pila
⑦ Botón de encendido/medición	⑧ Tecla más y menos/tecla de bloqueo	⑨ Botón de Apagar/Borrar
⑩ indicador de bloqueo	⑪ Burbuja de nivel	⑫ Área de visualización auxiliar
⑬ Pantalla de unidad	⑭ Conmutación de unidades/plano de nivel	⑮ Botón de interruptor de función/grabar



# Funciones básicas

## ● Encender / apagar

En el estado de apagado, mantenga presionado el botón . El dispositivo se enciende y entra en modo de espera.

En el estado de ejecución, mantenga presionado el botón  para apagar el dispositivo. Si no hay operación dentro de los 180 segundos, el dispositivo se cerrará automáticamente.

## ● Configuración de la unidad

En el modo de espera, mantenga presionado el botón  para cambiar la unidad. El dispositivo ofrece 6 opciones.

Unidad	Longitud	Área	Volumen
1	0.000 m	0.000 m <sup>2</sup>	0.000 m <sup>3</sup>
2	0.00 m	0.00 m <sup>2</sup>	0.00 m <sup>3</sup>
3	0.0 in	0.00 ft <sup>2</sup>	0.00 ft <sup>3</sup>
4	0 $\frac{1}{16}$ in	0.00 ft <sup>2</sup>	0.00 ft <sup>3</sup>
5	0'00" $\frac{1}{16}$	0.00 ft <sup>2</sup>	0.00 ft <sup>3</sup>
6	0.00 ft	0.00 ft <sup>2</sup>	0.00 ft <sup>3</sup>

## ● Establecer plano de referencia

Pulse brevemente el botón  para seleccionar el plano de nivel. El valor predeterminado es la medición bilateral.

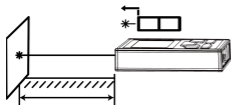

Plano de nivel frontal izquierdo

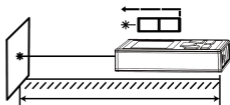

Plano de nivel trasero izquierdo

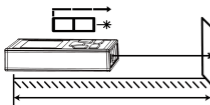

Plano de nivel trasero derecho

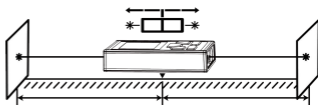

medición bilateral

## ● Selección del modo de medición

Presione brevemente el botón  para ingresar a la selección de modo. Visualizar como sigue:











Presione brevemente el botón  o  para cambiar de modo;



Presione brevemente el botón  para seleccionar el modo;

Pulse brevemente el botón  para volver.

Hay nueve modos de medición en el dispositivo:

	medición de longitud		Medición de ángulo y altura
	Medición de área		Medición de altura indirecta
	Medición de volumen		Medida de hipotenusa
	Medición del área de la pared		Medición de altura indirecta doble
			Medición de altura auxiliar

## ● Girar y bloquear la pantalla

El dispositivo admite la rotación automática de la pantalla, mantenga presionado el botón  para bloquear la orientación de la pantalla y la pantalla muestra . Mantenga presionada la tecla  para cancelar el bloqueo de orientación de la pantalla.

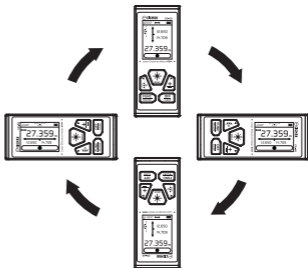

## ● Nivel de burbuja electrónico

El dispositivo está equipado con un nivel electrónico para medir el nivel de la superficie.

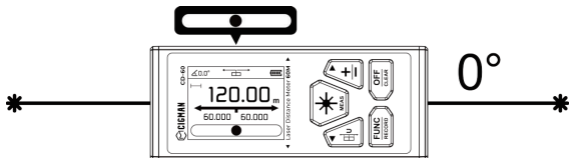

## ● Fuerte adsorción magnética

Hay un imán en la parte posterior de la herramienta, que puede adsorber la superficie del metal.

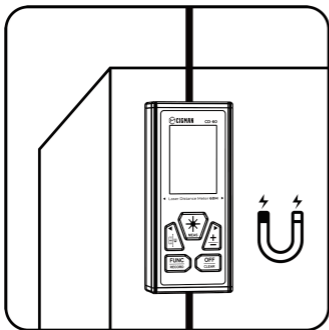

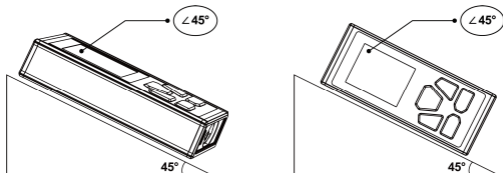

## ● Medición de ángulos

El equipo tiene un sensor de inclinación incorporado, que puede medir la inclinación del fondo y la inclinación lateral en tiempo real.







## Funciones de medición

### ● Medición de longitud - medición única :



Presione el botón  debajo de la medición de longitud, el dispositivo emitirá un punto láser para ubicar la posición de medición. Luego presione el botón  nuevamente para una sola medición de datos de distancia. El valor medido se muestra en el área de visualización principal. Durante la medición bilateral, el área de visualización auxiliar muestra las distancias en el lado izquierdo y derecho respectivamente.

### ● Medición de longitud - medición continua :



En la medición de longitud, presione y mantenga presionada la tecla  para ingresar al estado de medición continua, y la pantalla mostrará datos de medición en tiempo real, valores máximos y mínimos; Presione brevemente el botón  o  una vez para pausar la medición, presione estos dos botones nuevamente para detener la medición continua.



Búsqueda central: configure el plano de referencia en bidireccional, mantenga presionada la tecla  para iniciar la medición continua y encuentre el centro de acuerdo con las siguientes indicaciones. (Al usar la medición bilateral, puede haber un error de 1 mm en las lecturas izquierda y derecha).

Visualización de pantalla horizontal:

1. La pantalla muestra  , muévela hacia la izquierda.
2. La pantalla muestra  , muévela hacia la derecha.

Visualización de pantalla vertical:

1. La pantalla muestra  , muévela hacia arriba.
2. La pantalla muestra  , muévela hacia abajo.

Cuando la pantalla muestra   , significa que actualmente se encuentra en el punto medio.

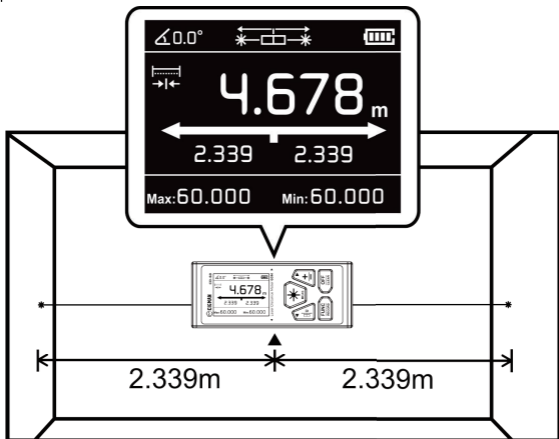

## ● Medición de área :

Presione el botón  para medir el primer lado (largo).

Presione el botón  para medir el segundo lado (ancho).

El dispositivo calculará automáticamente el área y la mostrará en el área de visualización principal. El área de visualización auxiliar muestra las medidas de largo y ancho. Durante la medición, también puede presionar el botón  para borrar la lectura actual y volver a medir.

## ● Medición de volumen :

1. Presione el botón  para medir el primer lado (longitud).

2. Presione el botón  para medir el segundo lado (ancho).

3. Presione el botón  para medir el tercer lado (altura).

4. El dispositivo calculará automáticamente el volumen y lo mostrará en el área de visualización principal. El área de visualización auxiliar muestra los valores medidos de la longitud, el ancho y la altura del cubo.

Durante la medición, también puede presionar el botón  para borrar la lectura actual y volver a medir.

## ● Medición del área de la pared :

1. Presione el botón  para medir la altura de la pared;

2. Presione el botón  para medir el ancho 1 de la pared 1;

El dispositivo calculará automáticamente el área de la pared = alto x ancho 1;

3. Presione el botón  para medir el ancho 2 de la pared 2;

El dispositivo calculará automáticamente la suma del área de la pared;

Suma del área = altura x (ancho 1+ancho 2);

4. Por analogía, presione el botón  para medir el ancho n de la pared n;

Suma del área = altura x (ancho 1+ancho 2+...+ancho n);

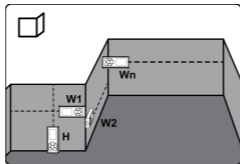

Durante la medición, también puede presionar el botón  para borrar la lectura actual y volver a medir.

## ● Medición indirecta:

① Mida el ángulo y la altura de un triángulo rectángulo  (como se muestra en la figura 1).

Presiona el botón  y sigue las instrucciones en la pantalla para medir la longitud de la hipotenusa (**a**).

El dispositivo puede medir simultáneamente el ángulo entre la hipotenusa y el lado de la base ( **$\theta$** ).

El dispositivo puede calcular automáticamente la distancia horizontal (**b**) y la altura vertical (**h**).

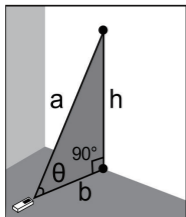

(figura 1)

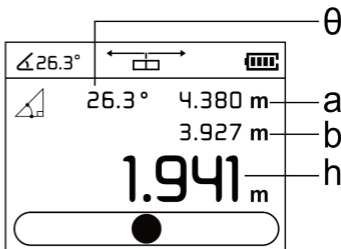



(visualización de la pantalla)



② Mida la altura de un triángulo rectángulo



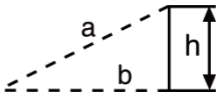

1. Presione el botón  y siga las indicaciones en la pantalla para medir la longitud de la hipotenusa (**a**).
2. Presione el botón , luego mida la longitud del lado en ángulo recto (**b**).
3. El dispositivo calculará automáticamente la altura (**h**) del triángulo después de la segunda medición.



(figura 2)

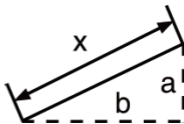

③ Mida la hipotenusa de un triángulo rectángulo  (como se muestra en la figura 3).

1. Presione el botón  para medir la longitud de un lado de acuerdo con la indicación en la pantalla (**a**).
2. Presione el botón  para medir la longitud de un borde en ángulo recto (**b**).
3. El dispositivo calculará automáticamente la hipotenusa (**x**) del triángulo después de la segunda medición.



(figura 3)

④ Mida la altura indirecta doble de un triángulo isósceles  (como se muestra en la figura 4).

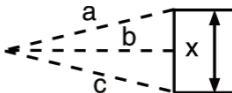

1. Presione el botón  y siga las instrucciones en pantalla para medir la longitud de una hipotenusa (**a**).
2. Presione el botón , luego mida la longitud del borde en ángulo recto (**b**).
3. Presione el botón  para medir la longitud de la otra hipotenusa (**c**).
4. Después de la medición, el dispositivo calcula automáticamente la altura del triángulo (**x**).



(figura 4)

⑤ Mida la altura auxiliar del triángulo

 (como se muestra en la figura 5).

1. Presione el botón  y siga las indicaciones en la pantalla para medir la longitud de una hipotenusa (**a**).
2. Presione el botón  para medir la longitud del otro lado (**b**).
3. Presione el botón  para medir la longitud de otra hipotenusa (**c**).
4. Después de la medición, el dispositivo calculará automáticamente la altura auxiliar (**X**) del triángulo.

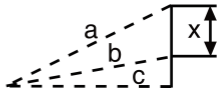

(figura 5)

### Aviso:

En el modo de medición pitagórico, el dispositivo solo puede calcular la longitud del lado del ángulo recto, que debe ser menor que la hipotenusa. De lo contrario, el dispositivo mostrará una señal de error.

En el modo de medición pitagórico, para garantizar la precisión, debe medirse desde el mismo punto de partida y medirse en el orden de la hipotenusa y el ángulo recto.

## ● Medición de sumas y restas:

1. Suma y resta acumulada de longitud



En la medida de longitud, mide un récord.

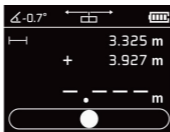

Presione brevemente el botón  para ingresar al modo acumulativo.



Luego mida los datos, el dispositivo acumulará y sumará automáticamente.

Presione brevemente el botón , aparecerá "+" en el área de visualización principal para ingresar al modo de medición de suma acumulativa. Luego continúe con la medición, y el dispositivo automáticamente agregará acumulativo.

En el modo acumulativo, presione brevemente el botón  nuevamente. El ícono "-" aparecerá en el área de visualización principal para ingresar al modo de medición de resta acumulativa. A continuación, continúe con la medición y el dispositivo realizará automáticamente una resta acumulativa.

## 2. Área, Volumen en sumas y restas acumuladas

Las operaciones de suma y resta de Volumen acumulado son las mismas que las operaciones de suma y resta de Área acumulada. Aquí está la muestra para la suma y resta acumulada del área:



figura ①



figura ②





figura ③

Paso 1, mida el área una vez (como se muestra en la figura ①).

Paso 2, presione brevemente el botón , aparecerá "+" en el área de visualización principal, ingrese al modo de medición de suma acumulativa y luego mida la segunda área (como se muestra en la figura ②).





Paso 3, presione brevemente el botón  y el dispositivo calculará automáticamente la suma de las dos áreas (como se muestra en la figura ③).

Suma y resta acumulativa de volumen: en el paso 1, presione brevemente el botón  para ingresar a la acumulación, luego presione brevemente el botón  para cambiar al modo de resta acumulativa. las operaciones subsiguientes son similares a la suma acumulativa y no se describirán nuevamente.



Múltiples operaciones acumulativas de suma/resta:

En el paso 2, después de obtener el área por segunda vez, presione brevemente el botón  nuevamente. Puede continuar con sumas/restas acumulativas para la siguiente área. Finalmente, siga el paso 3 para obtener un resultado.

## Grabación

- Después de completar la medición del dispositivo, el resultado se almacenará automáticamente;
- Mantenga presionado el botón  para ver los registros; presione brevemente el botón  o  para mirar hacia atrás en los registros; Mantenga presionado el botón  para borrar todos los registros.

## Cargando

- El dispositivo muestra , lo que indica que la batería es insuficiente. Recuerda al usuario que debe cargarlo inmediatamente para evitar afectar la precisión de la medición..
- Utilice un cargador compatible con salida DC5V  $\geq$  1A para la carga, y se recomienda utilizar un cargador de teléfono móvil.
- Indicación de carga: el instrumento se desplaza a la pantalla , lo que indica que no está completamente cargado. Cuando muestra  y ya no se desplaza, significa que está lleno.
- Mantenimiento de la batería: si no lo usa durante tanto tiempo, se recomienda cargar completamente el dispositivo primero y recargarlo cada seis meses para evitar daños por descarga en la batería.

# Mensaje de error

Durante el uso, pueden aparecer los siguientes mensajes de error:

Señal	Razón	Solución
Err	Fuera de rango de medida	Deje que el dispositivo funcione en un rango de medición efectivo
Err1	La señal es demasiado débil <b>(pared negra, sobre la distancia de trabajo)</b>	Para medir puntos objetivo altamente reflectantes <b>(una pared u objetivo de color claro)</b>
Err2	La señal es demasiado fuerte <b>(superficies interiores lisas (baldosas, superficies lisas pintadas, etc.)</b>	Para medir puntos objetivo débilmente reflectantes <b>(una pared u objetivo de color claro)</b>
Err3	Batería baja	Por favor cargue
Err4	Fuera del rango de temperatura de funcionamiento	Deje que el dispositivo se utilice en el entorno especificado.
Err5	Violaciones de medidas pitagóricas	Vuelva a medir para asegurarse de que la hipotenusa sea más grande que el lado del ángulo recto
Err6	Error del sensor de ángulo	Devolución a fábrica para reparación

# Mantenimiento de rutina del dispositivo

- Está prohibido almacenar el dispositivo en un ambiente de alta temperatura y alta humedad durante mucho tiempo. Cuando el dispositivo no se use durante mucho tiempo, coloque el dispositivo en la caja del dispositivo aleatorio y guárdelo en un lugar fresco y seco.
- Mantenga limpia la superficie del dispositivo, limpie el polvo de la superficie con un paño suave húmedo y no limpie el dispositivo con lociones corrosivas. La ventana del láser y el espejo de enfoque se pueden limpiar de la misma manera que la mesa de la óptica.
- En entornos hostiles como: 1. la luz del sol es demasiado fuerte, 2. la temperatura ambiente fluctúa demasiado, 3. el efecto de la superficie reflectante es débil, 4. la batería es insuficiente. La precisión se verá afectada por estos entornos. En este caso, es mejor usar el reflector de destino.

# Parámetros técnicos

Función	Descripción
Distancia máxima de medida	60m (unidireccional) 120m (bilateral)
Distancia mínima de medida	0,05m
Precisión de la medición	$\pm(2\text{mm}+d*1/10000)$ * (unidireccional)
Rango de medida de inclinación	$\pm 90^\circ$
Medición continua	✓
Medición de área y volumen	✓
Medición del área de la pared	✓
Medida pitagórica	✓
Medición de ángulo y altimetría	✓
Suma y resta de longitud	✓
Visualización máx./mín.	✓
Burbuja de nivel electrónico	✓
Rotación automática de pantalla	✓
atracción magnética	✓
Clase de láser	II
Tipo de láser	630-670nm. <1mW
Apagado automático del láser	20 segundos
Apagado automático	180 segundos
Tiempo de luz de fondo	60 segundos
Fuente de alimentación	3,7V 850mAh Batería de Litio
Puerto de recarga	CC 5V 0,75A Type-C
Tiempo de trabajo	Unidireccional: 12000 veces; bilateral: 8000 veces
Temperatura de almacenamiento	-20°C~60°C
Temperatura de trabajo	0°C~40°C
Humedad de almacenamiento	20%~80%HR
Dimensiones	115*50*24,5mm

\* "d" indica la distancia real.

# 安全上の注意事項

 初めてお使いになる前に、安全についての説明と取扱説明書をよくお読みください。

 本製品を使用する前に、本取扱説明書に記載されているすべての操作方法と安全規定をよくお読みください。この取扱説明書に記載された使用方法を守らないと、機器の破損や測定精度への影響、使用者または第三者への危害を及ぼす恐れがあります。

 また、本機のレーザー発信器を不正に改造したり、性能を変更したりすることは一切禁止されています。本機は適切に保管し、子供が触れるような場所に置かず、無関係な人が使用しないようにお願いします。

 本機のレーザーを自分や他人の目などに照射することは禁止されています。また、反射率の高い物体の表面にレーザーを照射することも禁止されています。

 本機の電磁波が他の機器や装置と干渉する可能性があります。航空機や医療機器の近くでのご使用や、可燃性・爆発性の環境でのご使用は避けてください。

 廃棄された機器を家庭ごみと一緒に廃棄することはできません。国または地域の関連する法律や規制に従って廃棄してください。

# 製品特徴

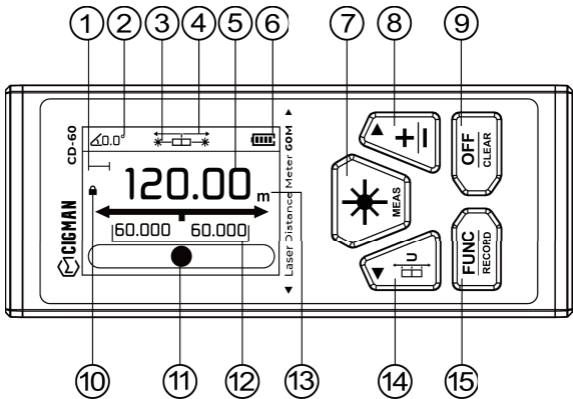



① 測定モード	② アングル表示	③ レーザー表示
④ ベンチマークの表示	⑤ メイン表示領域	⑥ 電源表示
⑦ 電源オン / 測定ボタン	⑧ 足し算 / 引き算 / 画面ロックボタン	⑨ 電源オフ / クリアボタン
⑩ 画面ロック表示	⑪ レベルバブル	⑫ 補助表示領域
⑬ 単位表示	⑭ 単位切替 / ベンチマーク測定	⑮ 機能とレコードボタン



# 基本機能

## ● 電源のオン / オフ

シャットダウン状態で、 ボタンを長押しします。機器が起動し、測定待ちモードになります。

動作状態で  ボタンを長押しすると、機器の電源が切れます。180 秒以内に操作がない場合、本機は自動的に電源を切ります。

## ● 単位の設定

 ボタンを長押しして単位切替の状態にすると、6 つの単位を選択することができます。

単位	長さ	面積	体積
1	0.000 m	0.000 m <sup>2</sup>	0.000 m <sup>3</sup>
2	0.00 m	0.00 m <sup>2</sup>	0.00 m <sup>3</sup>
3	0.0 in	0.00 ft <sup>2</sup>	0.00 ft <sup>3</sup>
4	0 $\frac{1}{16}$ in	0.00 ft <sup>2</sup>	0.00 ft <sup>3</sup>
5	0'00" $\frac{1}{16}$	0.00 ft <sup>2</sup>	0.00 ft <sup>3</sup>
6	0.00 ft	0.00 ft <sup>2</sup>	0.00 ft <sup>3</sup>

## ● ベンチマーク測定の設定

 ボタンを短く押すとベンチマークを測定し、初期設定はパイラテラル測定です。

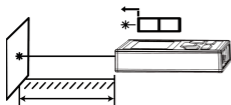

前方左側ベンチマーク

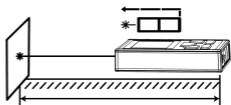

バックレフトベンチマーク

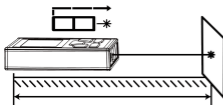

右上がりベンチマーク

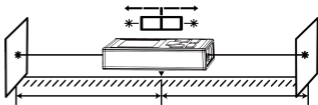



両側測定

## ● 測定モード選択

 ボタンを短く押し、モード選択に入ります。以下のように表示します：



 または  ボタンを短く押すと、モードが切り替わります。



 ボタンを短く押し、モードを選択します。

 ボタンを短く押すと元に戻ります。

本機には 9 つの測定モードがあります：

	長さ測定		角度および高さの測定
	面積測定		間接的な高さ測定
	体積測定		ハイポテンション測定
	壁面積の測定		二重間接高さ測定
			補助的な高さ測定

## ● 画面の回転とロック

本機は自動回転スクリーンを搭載しており、 ボタンを長押ししてスクリーンの向きをロックすると、スクリーンに  アイコンが表示されます。 ボタンを長押しすると、画面の方向ロックが解除されます。

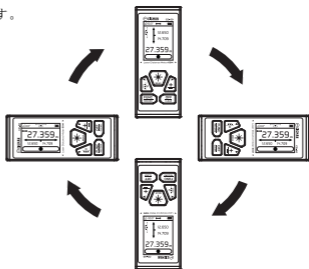

## ● 電子水準器バブル

電子式水平バブルに装着し、平面水平を測定することができます。

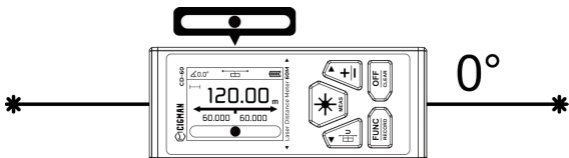

## ● 強力な磁気吸着

背面には磁石があり、金属の表面を吸着することができます。

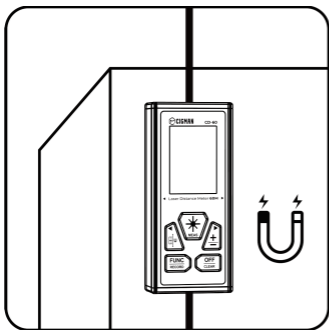

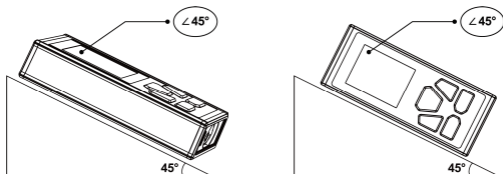

## ● 角度の測定

ダンブセンサーを内蔵しており、底辺と側面の角度をリアルタイムで計測することが可能です。







## 複数の測定機能

### ● 長さモード-1回測定 :

長さモードで  ボタンを押すと、機器がレーザーポイントを発信して測定位置をロックします。その後、もう一度  ボタンを押すと、単一距離データの測定が行われます。読み取り値は、メイン表示エリアに表示されます。両側測定では、補助表示エリアに左端と右端の距離が表示されます。

### ● 長さモード-連続測定 :

長さモードでは、 ボタンを押し続けると連続測定状態になり、画面にはリアルタイムの測定データ、最大値、最小値が表示されます。 ボタンを短押しするか、 ボタンを一度押して測定を一時停止し、これら2つのボタンをもう一度押して連続測定モードを終了します。

中間点検索：ベンチマークをバイラテラルベンチマークに設定し、 ボタン長押しで連続測定を開始し、以下のプロンプトに従って中間点を検索します。(両側レーザーで測定する場合、左右の測定値に 1mm 程度の誤差が生じることがあります)。

横画面表示:

1. 画面に【←】と表示されたら、左に移動してください。
2. 画面に【→】と表示されたら、右へ動かしてください。

縦画面表示:

1. 画面に【↑】と表示されたら、上に動かしてください。
2. 画面に【↓】と表示されたら、下に動かしてください。

→|← が表示されている場合は、現在中点であることを意味します。

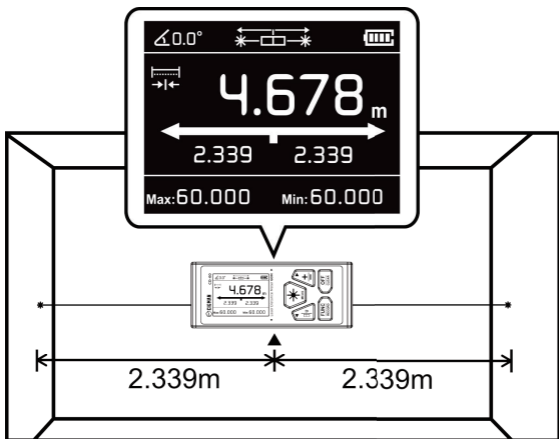

## ● 面積測定 :

 ボタンを押すと、1 辺（長さ）を測定します。

 ボタンを押すと、2 辺（幅）を測定します。

本機は自動的に面積を計算し、メイン表示エリアに表示します。補助表示エリアには、長さと同幅の測定値が表示されます。測定中に  ボタンを押すと、現在の測定値をクリアして再測定することもできます。

## ● 体積測定 :

1.  ボタンを押して、1 辺（長さ）を測定します。

2.  ボタンを押して、2 面（幅）を測定します。

3.  ボタンを押して、3 面（高さ）を測定します。

4. 本機は自動的に体積を計算し、主表示エリアに表示します。補助表示部には、立方体の長さ、幅、高さの測定値が表示されます。

測定中に  ボタンを押すと、現在の読み取り値をクリアして再測定することもできます。

## ● 壁面積の測定 :

1.  ボタンを押して、壁の高さを測定します。

2.  ボタンを押して、壁 1 の幅 1 を測定します。

本機は自動的に壁の面積 = 高さ × 幅 1 を計算します。

3.  ボタンを押して、壁 2 の幅 2 を測定します。

本機は自動的に壁の面積の合計を計算します。

面積の和 = 高さ × (幅 1 + 幅 2)

4. 類例として、 ボタンを押すと壁 n の幅 n が測定されます。

面積の和 = 高さ × (幅 1 + 幅 2 + … + 幅 n)。

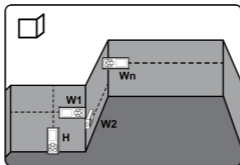

測定中に **OFF CLEAR** ボタンを押すと、現在の読み取り値をクリアして再測定することもできます。

## ● 間接的な測定:

① 直角三角形の角度と高さを測る  (図1のように)

 ボタンを押し、画面の指示に従って、斜辺の長さ(**a**)を測定します。

本機は同時に、斜辺と底辺のなす角 ( **$\theta$** )を測定することができます。

水平距離(**b**)、垂直高さ(**h**)を自動計算することができます。

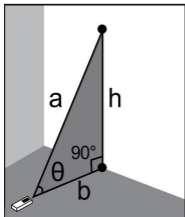

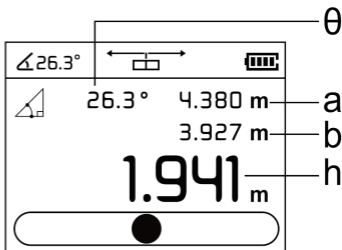

(図1)



(画面表示)



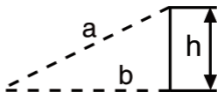

② 直角三角形の高さを測る  (図2のように)

1.  ボタンを押し、画面の指示に従って、斜辺の長さを測定します (**a**)。
2.  ボタンを押ししてから、直角の辺の長さを測定します (**b**)。
3. 2回目の測定後、本機は自動的に三角形の高さ(**h**)を算出します。



(図2)



③ 直角三角形の斜辺を測る  (図3)。

1.  ボタンを押し、画面上の指示に従って一辺の長さを測定します (**a**)。
2.  ボタンを押し、直角の辺の長さを測定します (**b**)。
3. 2回目の測定後、三角形の斜辺 (**x**) を本機が自動的に算出します。



(図3)

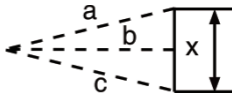

④ (二等辺三角形の二重間接高さを測る  (図4のように)

1.  ボタンを押し、画面の指示に従って、1本の斜辺の長さ (**a**)を測定します。
2.  ボタンを押ししてから、直角の辺の長さを測定します (**b**)。
3.  ボタンを押し、もう一方の斜辺の長さ(**c**)を測定します。
4. 測定後、本機は自動的に三角形の高さ(**x**)を計算します。



(図4)

⑤ 三角形の補助高さを測る  (図 5 のように)

1.  ボタンを押し、画面の指示に従って、斜辺(a)の長さを測定します。
2.  ボタンを押し、反対側の長さを測定します。(b)
3.  ボタンを押し、もう一つの斜辺(c)の長さを測定します。
4. 測定後、本機は自動的に三角形の補助高さ(X)を算出します。

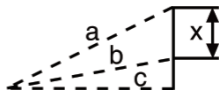

(図 5)

### ご注意:

ピタゴラススイッチの測定モードでは、本機が計算できるのは、直角の辺の長さが斜辺より小さくなければなりません。そうでない場合、本機はエラーシグナルを表示します。ピタゴラススイッチの測定モードでは、精度を確保するために、同じ出発点から測定し、斜辺、直角の順番で測定する必要があります。

## ● 足し算、引き算の測定:

### 1. 長さの累積加算と減算



長さモードでは、一連のデータを測定します。

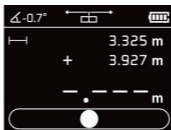

 ボタンを短押しして、累積モードに入ります。

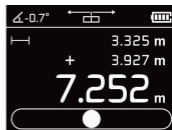

次に、データを測定すると、本機は自動的にデータを蓄積し、合計します。

 ボタンを短押しすると、メイン表示部に「+」が表示され、累積加算測定モードに入ります。その後、測定を続けると、本機は自動的に累積加算を行います。

累積測定モードで、もう一度  $\pm$  ボタンを短押しします。メイン表示部に「-」アイコンが表示され、累積減算測定モードになります。その後、測定を継続すると、本機は自動的に累積減算を行います。

## 2. 面積、体積の累積加算と減算

体積の累積加算・減算の操作は、面積の累積加算・減算と同じです。面積の累積加算・減算のサンプルは下記の通りになります。

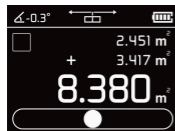

図①



図②



図③

手順1、面積を1回測定します（図①のように）。

手順2、 $\pm$  ボタンを短く押すとメイン表示部に「+」が表示され、累積加算測定モードに入り、2回目の面積を測定します（図②のように）。

手順3、 $\ast$  ボタンを短押しすると、2つの面積の合計を自動的に計算します（図③のように）。





体積の累積加算と減算:

手順1では、 $\pm$  ボタンを短押しして累積に入り、 $\pm$  ボタンを短押しして累積減算モードに切り替えます。その後の操作は累積加算と同様なので、改めて説明することはありません。



複数の累積加算・減算操作:

手順2において、2回目の面積を取得した後、再度  $\pm$  ボタンを短押しします。次の面積の累積加算/減算を続けることができます。最後に、手順3に従って、結果を得ます。

## レコーディング

- 機器測定が終了すると、結果が自動的に保存されます。
-  ボタンを長押しすると記録を見ることができ、 または  ボタンを短く押すと記録を振り返ることができ、 ボタンを長く押すとすべての記録をクリアすることができます。

## 充電

-  が画面に表示され、バッテリー残量が不足していることを示します。測定精度に影響を与えないよう、すぐに充電するよう使用者に注意を喚起します。
- 充電には DC5V $\geq$ 1A 出力の準拠した充電器を使用してください、スマホの充電器を使用することをお勧めします。
- 充電中表示: 本機がスクロールして  を表示するのは、完全に充電されていないことを意味します。  を表示しスクロールがなくなると、満充電を意味します。
- バッテリーのメンテナンス: 長期間使用しない場合は最初にフル充電し、バッテリーの放電損傷を防ぐために 6 ヶ月ごとに充電することをお勧めします。

# 即時の情報提供

使用中に、メイン表示部に以下のようなプロンプト情報が表示されることがあります：

信号	理由	対応策
Err	測定範囲外	効果的な測定範囲で機器を動作させる
Err1	信号が弱すぎる(黒壁、作業距離超過)	反射率の高いターゲットポイント(淡色の壁やターゲット)を測定します。
Err2	信号が強すぎる(屋内平滑面、タイル、平滑塗装面など)	反射率の弱いターゲットポイント(薄色の壁やターゲット)を測定します。
Err3	電池電圧が低すぎる	電池を充電します。
Err4	動作温度範囲外	指定された環境で本機を使用させる
Err5	sピタゴラスの測定法違反	斜辺が直角の辺より大きいことを確認するために再測定を行う。
Err6	角度センサーエラー	修理のため、工場に返送する

## 機器の定期メンテナンス

- 高温多湿の環境での長期間の保管は禁止されています。長期間使用しない場合は、ランダムな収納ケースに入れ、涼しく乾燥した場所に保管してください。
- 常に清潔に保ち、湿った柔らかい布で表面のほこりを拭き、腐食性のあるローションで器具を洗淨しないでください。レーザーウィンドウとフォーカシングミラーは、光学系テーブルと同じ方法でクリーニングすることができます。
- 以下のような劣悪な環境下では使用できません。1.日差しが強すぎる、2.周囲温度の変動が激しい、3.反射面の効果が弱い、4.電池が不足している。これらの環境では、精度に影響を及ぼします。このような場合は、ターゲットリフレクターを使用することをお勧めします。

# 技術仕様

機能	説明
最大測定距離	60m ( 単方向 ) 120m ( 双方向 )
最小測定距離	0.05m
測定精度	$\pm(2\text{mm}+d*1/\text{万分の } 1)^*$ ( 単方向 )
傾斜測定範囲	$\pm 90^\circ$
連続測定	✓
面積と体積の測定	✓
壁面積の測定	✓
ピタゴラスの測定	✓
角度と高度の測定	✓
長さの足し算と引き算	✓
最大/最小表示	✓
電子水準器バブル	✓
自動切替画面	✓
磁気吸着	✓
レーザークラス	II
レーザータイプ	630-670nm, <1mW
オートカットオフレーザー	20 秒
自動電源オフ	180 秒
バックライト時間	60 秒
電源	3.7V 850mAh リチウム電池
充電用ポート	DC5V 0.75A Type-C
作業時間	単方向: 12000 回、双方向: 8000 回
保存温度	-20℃~60℃
使用温度	0℃~40℃
保存湿度	20%~80%RH
寸法	115*50*24.5mm

\* d は実際の距離です。

# Three Years Warranty

Garantía de 3 AÑOS

Garantie de 3 ans

Drei-Jahren-Garantie

Tre anni di garanzia

3 年間保証

Contact us: [support@cigman.com](mailto:support@cigman.com)



YH Consulting Limited  
C/O YH Consulting Limited Office 147, Centurion House,  
London Road, Staines-upon-Thames, Staines, Surrey,  
London, TW18 4AX  
+44 07514-677868  
H2YHUK@gmail.com



E-CrossStu GmbH  
Mainzer Landstr. 69, 60329, Frankfurt am Main, Germany  
e-crossstu@outlook.com  
+49 69332967674



Points de collecte sur [www.quefairedemesdechets.fr](http://www.quefairedemesdechets.fr)



Points de collecte sur [www.quefairedemesdechets.fr](http://www.quefairedemesdechets.fr)