

KAIWEETS

User Manual

Smart Digital Multimeter

ST600X & ST600Y

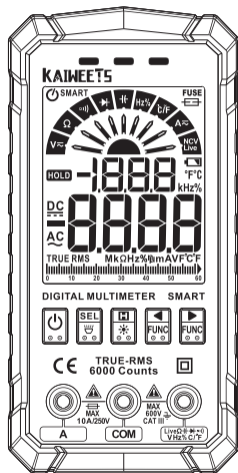

CE UK CA RoHS MADE IN CHINA FC

Contact us: support@kaiweets.com

To view, print, or download the latest manual or manual supplement, visit <https://kaiweets.com/pages/downloads>



Go to Kaiweets YouTube channel to watch a How-to Guide and find more information about your Product.



Points de collecte sur www.quefairedemesdechets.fr



Points de collecte sur www.quefairedemesdechets.fr

Languages

Instruction manual - English.....	1-21
Gebrauchsanweisung - Deutsch.....	22-44
Manuel d'instruction - Français.....	45-67
Manual de instrucción - Español.....	68-90
Manuale di istruzioni - Italiano.....	91-113
3 years warranty.....	114

EN Instruction manual

Contents

Safety Information	1
Product Familiarization	4
Overview.....	4
Features.....	5
Making Measurements	7
SMART (AUTO) Measurement Mode.....	7
Turn On & Ready to Use.....	8
Smart Mode.....	9
MANUAL Measurement Mode.....	10
AC/DC Voltage Measurement.....	10
Resistance Measurement.....	10
Continuity Test.....	11
Frequency/Duty measurement.....	11
Diode Test.....	12
Capacitance Measurement.....	13
Temperature Measurement.....	13

Non-contact AC Voltage Detection.....	14
Live Wire Detection.....	14
AC/DC Current Measurement.....	15
Specifications.....	16
Accuracy Specifications.....	17
Maintenance.....	20
Cleaning.....	20
Install Batteries.....	20
Replace Fuses.....	21

Safety Information

The Meter conforms to IEC61010-1 CAT.III 600V overvoltage safety standard and pollution level 2. A Warning identifies conditions and procedures that are dangerous to the user.

Warnings

To prevent possible electrical shock, fire, or personal injury:

- Read all safety information before you use the product.
- Do not alter the product and use only as specified, or the protection supplied by the product can be compromised.
- Comply with local and national safety codes. Use personal protective equipment (approved rubber gloves, face protection, and flame-resistant clothes) to prevent shock and arc blast injury where hazardous live conductors are exposed.
- Limit operation to the specified measurement category, voltage, or amperage ratings.
- Use product-approved measurement category (CAT), voltage, and amperage-rated accessories (probes, test leads, and adapters) for all measurements.

- Do not touch voltages >30V AC RMS, 42V AC peak, or 60V DC.
- Use the correct terminals, function, and range for measurements.
- Do not use the product around explosive gas, vapor, or in damp or wet environments.
- Do not operate the product with covers removed or the case open. Hazardous voltage exposure is possible.
- Examine the case before you use the product. Look for cracks or missing plastic. Carefully look at the insulation around the terminals.
- Disconnect power and discharge all high-voltage capacitors before you measure resistance, continuity, capacitance, or a diode junction.
- Do not apply more than the rated voltage, between the terminals or between each terminal and earth ground.
- Remove circuit power before you connect the product in the circuit when you measure current. Connect the product in series with the circuit.
- Measure a known voltage first to make sure that the product operates correctly.

- Do not use test leads if they are damaged. Examine the test leads for damaged insulation, exposed metal, or if the wear indicator shows. Check test lead continuity.
- Remove the input signals before you clean the product.
- When measuring, please connect the null or ground wire first, then the live wire; when disconnected, please disconnect the live wire first, and then the null or ground wire.
- Remove the probe from the meter before opening the case or battery cover. Do not use the meter when the meter is disassembled or the battery cover is opened.
- The meter can only be used together with the probe provided to meet the requirements of the safety standard. If the probe is damaged and needs to be replaced, the probe of the same model and electrical specification.





Product Familiarization

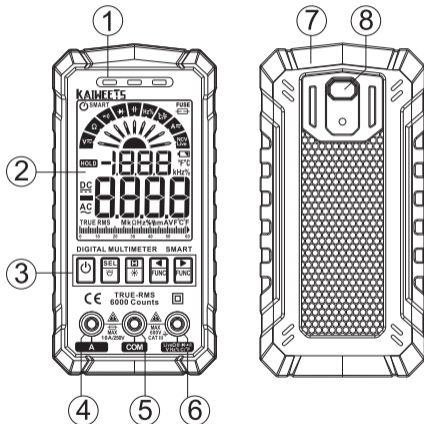





Overview

- ① Alarm Indicator
- ② LCD Screen
- ③ Function Buttons
- ④ Current Input Jack
- ⑤ COM Jack
- ⑥ Jack for other functions
- ⑦ NCV Sensor
- ⑧ Flashlight



Features

Button	Function
	Press and hold the '⏻' button for about 2 seconds to turn on/off the Meter. Power on is in SMART mode by default.
	Press the '← FUNC' button to select functions from right to left. Press the '→ FUNC' button to select functions from left to right. Press '← FUNC' or '→ FUNC' button for about 2 seconds to return to SMART mode.
 ST600X	 ST600Y Press ' [H] / [H] ' button to turn on/off data holding. Press ' [H] ' button for about 2 seconds to turn on/off backlight. *Only ST600X.
	Press ' SEL ' button to select functions. *Only valid for voltage test, current test and NCV/LIVE test. Press ' SEL ' button for about 2 seconds to turn on/off flashlight.

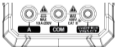
Symbol	Description
 <p data-bbox="122 277 353 311">Damaged Fuse</p>	<p data-bbox="414 180 1521 337">If the fuse is burnt out, the symbol '  ' will be displayed. In current test, the symbol ' FUSE ' will also be displayed. The current can only be measured after replacing the good fuse.</p>
 <p data-bbox="122 612 353 646">Auto Power Off</p>	<p data-bbox="414 368 1455 462">The Auto Power Off function by default at boot and '  ' symbol will be displayed.</p> <p data-bbox="414 484 1529 578">Without any operation in about 15 minutes, the Meter will automatically turn off. 1 minute before turn off, there will be 5 beeps.</p> <p data-bbox="414 600 1554 694">Press and hold both '  ' and '  ' buttons to turn on meter, the auto power off function will be canceled. The '  ' symbol is not displayed.</p>
 <p data-bbox="133 824 353 858">Jack Indication</p>	<p data-bbox="414 764 1542 857">When switching to other functions the light above the corresponding jack will flash for users to insert the right test leads to the right jack.</p>

Making Measurements

When connecting the test leads to the circuit or device, connect the common (COM) test lead before connecting the live lead; when removing the test leads, remove the live lead before removing the common test lead.

Warnings

- **Do not measure the voltage higher than 600V, otherwise, the Meter may be damaged.**
- **Pay attention when measuring high voltage to avoid electric shock or personal injury.**
- **Before use, test the known voltage or current to confirm that the Meter is in good condition.**

SMART (AUTO) Measurement Mode

The Meter defaults to SMART mode. In the SMART mode, the Meter can test DC voltage, AC voltage, resistance, continuity, it selects the range with the best resolution automatically.

Turn on & Ready to use

1. Long press for about 2 seconds the '  ' button to turn on the Meter, ' **Auto** ' will be displayed on the screen, and the pointer will swing by itself, indicating the SMART mode.
2. Insert the red probe into ' **Live** ' jack and the black probe into the ' **COM** ' jack.
3. Touch the red test lead and the black test lead to check whether they are normal. The buzzer will beep and the indicator light will be on if normal.

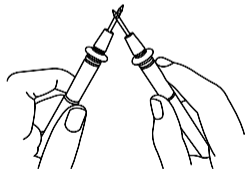
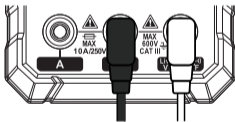

Smart Mode

Connect the test leads with both ends of the circuit or resistance (in parallel), the Meter automatically selects measurement based on the input.



NOTE:

The minimum measurable voltage in SMART mode is 0.8V.

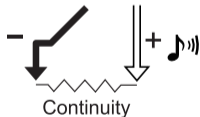
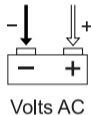
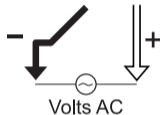

When measuring resistance, if the resistance value is less than 50Ω , the Meter will beep and the indicator will light up.



MANUAL Measurement Mode

The Meter defaults to SMART mode. In the SMART mode, press the '' or '' button to switch to manual mode and select function.

AC/DC Voltage Measurement

- 1) Turn on & Ready to use (look at page 8)
- 2) Press the '' button to ' $V \approx$ ' setting,
- 3) ' DC ' signal will be displayed on the screen, indicating DC voltage measurement.
- 4) Press the '' button to AC voltage test, ' AC ' signal will be displayed on the screen, indicating AC voltage measurement.



Resistance Measurement

- 1) Turn on & Ready to use (look at page 8)
- 2) Press '' button to select ' Ω ' gear. ' Ω ' signal will be displayed on the screen, indicating the resistance measurement.



NOTE:

Do not directly measure the internal resistance of micrometers, galvanometers, batteries, and other instruments.

Continuity Test



- 1) Turn on & Ready to use (look at page 8)
- 2) Press '  ' button to ' ) ' setting, indicating the continuity measurement.
- 3) Connect the test leads to both ends of the circuit under test (in parallel).
- 4) If the resistance of the circuit or resistor under test is less than 50Ω and the circuit is on position, the buzzer will beep and an indicator light will light up, and the screen will display the measured resistance value.

Frequency/Duty Measurement

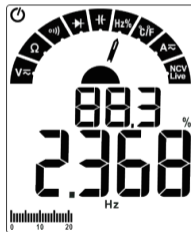
- 1) Turn on & Ready to use (look at page 8)
- 2) Press the '  ' button or '  ' to 'Hz%' setting, ' Hz ' signal and ' % ' signal will be displayed on the screen, indicating Frequency/ Duty Ratio testing.



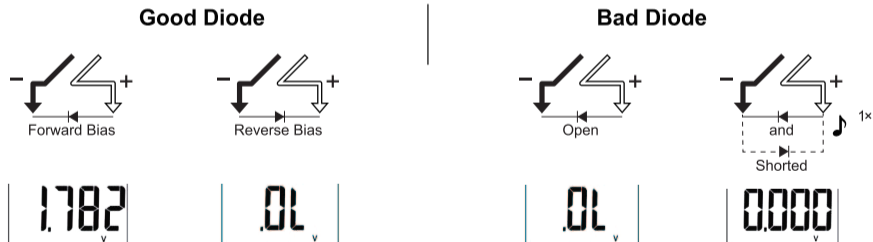

Diode Test

- 1) Turn on & Ready to use (look at page 8)
- 2) Press '  ' button to '  ' setting, indicating the diode testing.
- 3) Connect red test lead with the positive polarity of the diode, black test lead with the negative polarity of the diode.
- 4) If the test leads are connected reversely with the diode polarity, ' **OL** ' will be displayed.





Capacitance Measurement

- 1) Turn on & Ready to use (look at page 8)
- 2) Press '' button or '' to '

* Before measuring the capacitor, discharge the capacitor to avoid damage to the Meter.

* If the capacitance is large, it may take a long time for the reading to stabilize.

Temperature Measurement

- 1) Turn on & Ready to use (look at page 8)
- 2) Insert the positive pole of the K-type thermocouple into the '' button or '' to '**°C/°F**' setting, '**°C**' signal and '**°F**' signal will be displayed on the screen, indicating temperature testing.
- 4) Touch to the object being measured.
- 5) The reading may take few seconds to be stable.

Non-contact AC Voltage Detection

- 1) Turn on & Ready to use (look at page 8)
- 2) Press the '  ' button to ' **NCV/LIVE** ' setting, ' **NCV** ' signal will be displayed on the screen.
- 3) Place the NCV probe closer to the point to be tested gradually.



When the Meter detects a weak signal, the green indicator will light up, the buzzer will beep in a slow tone, and ' **--L** ' will be displayed on the screen.

When the Meter detects a strong signal, the red indicator will light up, the buzzer will beep in a fast tone, and ' **--H** ' will be displayed on the screen.

Live Wire Detection

- 1) Turn on & Ready to use (look at page 8)
- 2) Press the '  ' button to ' **NCV/LIVE** ' setting
- 3) Press the ' **SEL** ' button to ' **LIVE** ' mode.
- 4) Insert the red probe into the ' **LIVE** ' jack and remove the black probe. (Live Ω (H → Ω) , VHz% C/F)
- 5) Touch the object with the test lead point.
- 6) When the indicator light lights up that means the measured position for the fire line, please be careful!

AC/DC Current Measurement

- 1) Turn on & Ready to use (look at page 8)
- 2) Insert the red probe into the ' **A** ' jack and the black probe into the ' **COM** ' jack. The Meter will automatically adjust to the ' **A \approx** ' gear.
- 3) ' **DC** ' signal and ' **mA** ' signal will be displayed on the screen, indicating DC current measurement.
- 4) Press the ' **SEL** ' button, ' **mA** ' signal and ' **AC** ' signal will be displayed on the screen, indicating AC current measurement.

Note:

- When measuring AC current, the frequency will be displayed, and when measuring DC current, the ambient temperature will be displayed on the screen.
- ' **LEAD** ' signal will be displayed on the screen when the test leads are connected incorrectly, please insert the red test lead into ' **A** ' Jack.
- The Meter will turn to the current testing when you insert the lead into ' **A** ' Jack and ' **COM** ' Jack. For safety, users cannot switch the functions.
- Do not measure current > **10A** in this gear, in case of the fuse burning.



Specifications

Power	4×1.5V AAA batteries
Environmental conditions	CAT. III 600V ; Pollution level 2, Altitude < 2000m
MAX. Voltage between terminals and earth ground	DC/AC 600V
Fuse protection	F10A/250V fuse
Work environment	0-40°C(<80% RH, <10°C non condensing)
Storage temperature	-10~60°C(<70% RH, remove the battery)
Temperature coefficient	0.1 x accuracy/°C(< 18°C or >28°C)
Sampling rate	Approx. 3 times/second
Display	6000 counts

Accuracy Specifications

Accuracy is specified for 1 year after calibration, at operating temperatures of 18 °C to 28 °C, with relative humidity at 0 % to 80 %.

Accuracy \pm ([% of Reading] + [Counts])

DC voltage

Range	Resolution	Accuracy
600mV	0.1mV	$\pm(0.5\% + 3)$ Impedance: Approx. 10M Ω
6V	0.001V	
60V	0.01V	
600V	1V	

AC voltage

Range	Resolution	Accuracy
6V	0.001V	$\pm(0.8\% + 3)$ Impedance: Approx. 10M Ω
60V	0.01V	
600V	1V	
Frequency Response: 40Hz~1kHz; T-RMS		

Resistance

Range	Resolution	Accuracy
600 Ω	0.1 Ω	$\pm(1.0\% + 5)$
6 k Ω	0.001 k Ω	
60 k Ω	0.01 k Ω	
600 k Ω	0.1 k Ω	
6 M Ω	0.001 M Ω	$\pm(1.5\% + 10)$
60 M Ω	0.01 M Ω	
Overload protection: 250V		

AC/DC current

Range	Resolution	Accuracy
600mA	0.1mA	$\pm(1.2\%+3)$
6A	0.001A	
10A	0.01A	
Overload protection: F10A/250V fuse Frequency Response: 40Hz~1 kHz; T-RMS		



Capacitance

Range	Resolution	Accuracy
6nF	0.001nF	$\pm(4.0\%+5)$
60nF	0.01 nF	
600nF	0.1nF	
6 μ F	0.001 μ F	
60 μ F	0.01 μ F	
600 μ F	0.1 μ F	
6mF	0.001 mF	$\pm(5.0\%+5)$
60mF	0.01 mF	
Overload protection: 250V		

Frequency/Duty

Range	Resolution	Accuracy
6Hz	0.001Hz	±(1.0%+3)
60Hz	0.01Hz	
600Hz	0.1Hz	
6KHz	0.001 KHz	
60kHz	0.01kHz	
600kHz	0.1kHz	
6MHz	0.001MHz	
10MHz	0.01MHz	
1.0-99.0%	0.1%	±(1.0%+3)
Overload protection: 250V		

Diode/Continuity

	Display diode voltage drop
	<Approx. 50Ω, Buzzer will sound and the indicator light will be on.

Temperature

Unit	Range	Accuracy
°C	-40 °C- 0°C	±3°C
	0°C -1000°C	±2.0% or±2°C
°F	-40°F~ 32°F	± 6°F
	32°F- 1832°F	±2.0% or±4°F
Resolution: 1°C/1°F		
Note: use K-type thermocouple probe		

Maintenance

Cleaning

- 1) Turn off the power to the Meter and remove the test leads.
- 2) Wipe the case with a damp cloth and mild detergent. Dirt or moisture in the terminals can affect readings.

Warning : Always keep the inside of the Meter clean and dry to prevent electric shock or damage.

Install Batteries

'  ' signal will be displayed on the screen when the battery is low.

- 1) Remove test leads from the Meter before opening the case or battery door.
- 2) Remove the screw and remove the battery door.
- 3) Install 4 x 1.5V AAA batteries. *Please pay attention to the battery polarity.
- 4) Then inserted into the battery door. Install and tighten the battery door screw.

Warning

- To avoid electric shock or personal injury caused by wrong reading, please replace the battery

immediately when the battery is low.

- Do not discharge the battery by shorting it or reversing its polarity.
- To operate and maintain the Meter safely, please take out the battery when it is not used for a long time to prevent the battery leakage from damaging the product.

Replace Fuses

'  ' signal will be displayed on the screen when the fuses are blown, current testing function is not working, please change the fuses.

- 1) Turn off the Meter power and remove the probes.
- 2) Remove the screw fixing the back cover and remove the back cover.
- 3) Remove the burnt-out fuse, replace it with a new one of the specification(**F10A/250V fuse**), and ensure that the fuse is installed in the safety clip and clamped tightly.
- 4) Install the back cover and fix it with screws.

Warning

- Use **ONLY** a fuse with the amperage, interrupt voltage, and speed ratings specified.
- Do not use the Meter if the back cover is opened.

DE Gebrauchsanweisung

Inhaltsverzeichnis

Sicherheitshinweise	24
Produktübersicht	26
Überblick.....	26
Funktionen.....	27
Messung starten	29
SMART (AUTO) Messung.....	30
Einschalten und Einführen.....	30
Smart-Modus.....	31
Manuell-Modus.....	32
AC/DC Spannungsmessung.....	32
Widerstandsmessung.....	32
Akustische Durchgangsprüfung.....	33
Frequenz- und Einschaltdauermessungen (Hz%).....	33
Diodentest.....	34
Kapazitätsmessung.....	35
Temperaturmessung.....	35
Kontaktlose Spannungsprüfung (NCV).....	36

Erkennung vom Außenleiter.....	36
Strommessung AC/DC.....	37
Technische Daten.....	39
Genauigkeit.....	40
Wartung.....	43
Reinigung.....	43
Batterien einsetzen.....	43
Sicherungen ersetzen.....	44

Sicherheitshinweise

Das Messgerät entspricht IEC 61010-1 CAT.III 600V Überspannungskategorie und Verschmutzungsgrad 2.

Warnung identifiziert gefährliche Bedingungen und Verfahren.

Warnung

Um einen möglichen Stromschlag, Brand oder Personenschäden zu vermeiden:

- Lesen Sie alle Sicherheitsinformationen, bevor Sie das Produkt verwenden.
- Verwenden Sie das Produkt nur wie angegeben, da sonst der vom Produkt bereitgestellte Schutz beeinträchtigt werden könnte.
- Tragen Sie persönliche Schutzausrüstung. Beschränken Sie den Betrieb auf die angegebene Messkategorie, Spannungs- oder Stromstärke-Nennwerte.
- Die Benutzung von nicht vom Hersteller angegebenen Messgeräten ist verboten. Seien Sie vorsichtig mit Spannungen über 30V AC RMS, 42V AC Spitze und 60V DC.
- Verwenden Sie die richtigen Anschlüsse, Funktionen und Bereiche.
- Benutzen Sie das Messgerät nicht in der Nähe explosiver Gase, Dampf oder Staub. Benutzen

Sie das Messgerät nicht in feuchter Umgebung.

- Überprüfen Sie das Gehäuse, bevor Sie das Messgerät verwenden. Verwenden Sie das Messgerät nicht, wenn es beschädigt ist oder das Gehäuse (oder ein Teil des Gehäuses) entfernt wurde. Suchen Sie nach Rissen oder fehlendem Kunststoff. Achten Sie auf die Isolierung um die Steckverbinder.
- Unterbrechen Sie die Stromversorgung und entladen Sie alle Hochspannungskondensatoren, bevor Widerstand, Durchgang, Kapazität oder ein Diodenübergang geprüft wird.
- Die Nennspannung zwischen den Buchsen oder zwischen Buchse und Erdung darf nicht überschritten werden.
- Wenn Sie den Strom messen, schalten Sie die Stromversorgung aus, bevor Sie das Messgerät im Stromkreis anschließen.
- Überprüfen Sie die Messfühler auf beschädigte Isolierung oder offenes Metall. Überprüfen Sie den Messfühlerdurchgang.







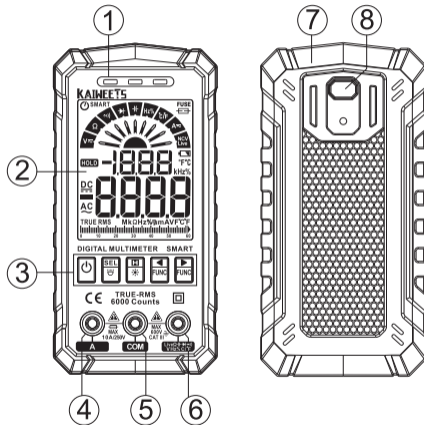

Produktübersicht









Überblick

- ① Alarmanzeige
- ② LCD Display
- ③ Funktionstasten
- ④ A Buchse
- ⑤ COM Buchse
- ⑥ Buchse für andere Funktionen
- ⑦ NCV-Sensor
- ⑧ Taschenlampe



Funktionen

Taste	Function
	Langdruck: Das Meter ein-/ auszuschalten. Der SMART-Modus ist standardmäßig aktiv.
 	Kurzdruck: die Mess funktionen von rechts nach links oder von links nach rechts auszuwählen. (Manuell-Modus). Langdruck: '  ' '  ' zum SMART-Modus zurückzukehren.
 ST600X	 ST600Y
	Kurzdruck: Sekundäre Funktion einzuwählen (AC/ DC, NCV/ Live) Langdruck: Taschenlampe ein-/auszuschalten.

Symbol	Beschreibung
 Beschädigte Sicherung	<p>Wenn die Sicherung durchgebrannt ist, wird das Symbol '  ' angezeigt.</p> <p>Im Test wird zusätzlich das Symbol ' FUSE ' angezeigt. Erst nach Austausch der guten Sicherung ist die Strommessung möglich.</p>
 Auto-Power-Off	<p>Standardmäßige Abschaltung: '  ' auf dem Bildschirm.</p> <p>Das Gerät schaltet sich nach 15 Minuten Inaktivität automatisch ab, um Energie zu sparen. 1 Minute vor der Abschalten ertönen 5 Pieptöne.</p> <p>Zum Deaktivieren der Abschaltautomatik halten Sie die Tasten '  ' und '  ', gedrückt, um das Messgerät einzuschalten. Das Symbol '  ' verschwindet.</p>
 Buchsenanzeige	<p>Beim Umschalten auf jegliche Funktion blinkt das Licht über der entsprechenden Buchse, damit der Benutzer die richtigen Messleitungen in die rechte Buchse einstecken kann.</p>

Messung starten

Schließen Sie das gemeinsame (COM) Testkabel an den Stromkreis an, bevor Sie das stromführende Kabel anschließen;

Entfernen Sie nach der Messung die stromführende Leitung, bevor Sie die gemeinsame (COM) Prüfleitung vom Stromkreis entfernen.



Warnung

- **Spannung über 600V kann nicht gemessen werden!**
- **Achten Sie beim Messen von Hochspannung auf die Sicherheit, um Stromschläge oder Verletzungen zu vermeiden.**
- **Vor dem Gebrauch testen Sie bekannte Spannung oder Stromstärke mit dem Messgerät ,um die Funktion des Geräts sicherzustellen.**

SMART (AUTO) Messung

Smart-Messung ist die Voreinstellung beim Einschalten. Die Messungen von Gleichspannung, Wechselspannung, Widerstand und Durchgang werden automatisch erkannt und durchgeführt.

Einschalten und Einführen

1. Halten Sie die '  ' Taste etwa 2 Sekunden lang gedrückt, um das Messgerät einzuschalten, ' **Auto** ' auf dem Bildschirm bedeutet aktive SMART-Messung und der Zeiger schwingt von selbst
2. Stecken Sie die rote Sonde in die '  **Live** ' Buchse. und die schwarze Sonde in die ' **COM** ' Buchse.
3. Berühren Sie die rote und die schwarze Messspitzen um die Verbindung zu überprüfen. Der Summer piept und die Kontrollleuchte leuchtet, wenn sie normal ist.

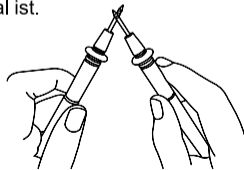
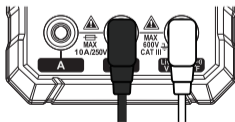

Smart-Modus

Verbinden Sie die Messleitungen mit beiden Enden des Stromkreises oder des Widerstands (parallel). Basierend auf der Eingabe, wählt automatisch das Messgerät die Messung basierend auf der Eingabe aus.

HINWEIS:

- Die minimale messbare Spannung im SMART-Modus beträgt 0,8V.
- Wenn der Widerstandswert bei der Widerstandsmessung weniger als 50Ω beträgt, piept das Messgerät und die Anzeige leuchtet auf.

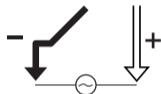

Wechselspannung



Gleichspannung



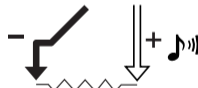

Widerstand





Durchgang

Manuell-Modus

Das Messgerät befindet sich standardmäßig im SMART-Modus. Drücken Sie im SMART-Modus die Taste '  ' oder '  ' um in den manuellen Modus zu wechseln und die Funktion auszuwählen.

AC/DC Spannungsmessung

- 1) Einschalten und Einführen (siehe Seite 30)
- 2) Drücken Sie die '  ' Taste zur ' $V \approx$ '
- 3) ' DC ' Signal erscheint auf dem Bildschirm, was die DC-Spannungsmessung anzeigt.
- 4) Drücken Sie die '  ' Taste, ' AC ' Signal erscheint auf dem Bildschirm und zeigen die AC-Spannungsmessung an.

Widerstandsmessung

- 1) Einschalten und Einführen (siehe Seite 30)
- 2) Drücken Sie die '  ' Messung Taste zur ' Ω '. ' Ω ' Signal erscheint auf dem Bildschirm. Nun ist die Widerstandsmessung durchzuführen.



HINWEIS:

Messen Sie den Innenwiderstand von Mikrometern, Galvanometern, Batterien und anderen Instrumenten nicht direkt.

Akustische Durchgangsprüfung



- 1) Einschalten und Einführen (siehe Seite 30)
- 2) Drücken Sie die Taste '  ' zur Durchgangsprüfung.
- 3) Schließen Sie die Prüflleitungen an beide Enden des zu prüfenden Stromkreises (parallel) an.
- 4) Wenn der Widerstand des zu testenden Stromkreises oder Widerstands weniger als 50 beträgt und der Stromkreis eingeschaltet ist, piept der Summer und, eine Kontrollleuchte leuchtet auf und der Bildschirm zeigt den gemessenen Widerstandswert an.

Frequenz- und Einschaltdauermessungen (Hz%)

- 1) Einschalten und Einführen (siehe Seite 30)
- 2) Drücken Sie die '  ' oder '  ' Taste zur Messung von 'Hz%'. Das ' Hz ' und ' % ' Signal erscheinen auf dem Bildschirm, was die aktive. Hz%-Messung-anzeigt.





Diodentest

- 1) Einschalten und Einführen (siehe Seite 30)
- 2) Drücken Sie die Tasten '  ' zur '  ' um die Diodenmessung einzuwählen.
- 3) Verbinden Sie die rote Messleitung mit der positiven Polarität der Diode, die schwarze Messleitung mit der negativen Polarität der Diode.
- 4) Wenn die Messleitungen mit der Diodenpolarität angeschlossen vertauscht sind, wird ' **OL** ' auf dem Bildschirm angezeigt.







Kapazitätsmessung

- 1) Einschalten und Einführen (siehe Seite 30)
- 2) Drücken Sie die '  ' oder '  ' Taste zur Messung von '  ', ' nF ' wird auf dem Bildschirm angezeigt. Der Kapazitätstest ist nun aktiv.

- * Wenn der gemessene Wert stark von dem auf dem Kondensator angegebenen Wert abweicht, ist der Kondensator beschädigt.
- * Wenn die Kapazität groß ist, kann es lange dauern, bis sich der Messwert stabilisiert hat.



Temperaturmessung

- 1) Einschalten und Einführen (siehe Seite 30)
- 2) IStecken Sie den Pluspol des K-Typ-Thermoelements in die '  Ω (f \rightarrow ∞) ', '  % C/F ' Buchse und den Minuspol in die ' **COM** ' Buchse.
- 3) Drücken Sie die '  ' Taste oder '  ' Taste zur Messung von ' °C/°F '. Das '°C' Signal und das '°F' Signal erscheinen auf dem Bildschirm. Es zeigt den Temperaturtest an.
- 4) Berühren Sie das zu messende Objekt mit dem Ende des K-Typ-Thermoelements.
- 5) Es kann einige Sekunden dauern, bis der Messwert stabil ist.

Kontaktlose Spannungsprüfung (NCV)

- 1) Einschalten und Einführen (siehe Seite 30)
- 2) Drücken Sie die '  ' Taste zur Einstellung ' **NCV/LIVE** ' das, ' **NCV** ' Signal wird auf dem Bildschirm angezeigt und zeigt den NCV-Test an.
- 3) Bewegen Sie die NCV-Sonde allmählich näher an den zu prüfenden Punkt.

Erkennung vom Außenleiter

- 1) Einschalten und Einführen (siehe Seite 30)
- 2) Drücken Sie die '  ' Taste zur Einstellung ' **NCV/LIVE** '
- 3) Drücken Sie die ' **SEL** ' Taste, bis das ' **LIVE** ' Symbol anzeigt.
- 4) Stecken Sie die rote Sonde in die '  ' Buchse und entfernen Sie die schwarze Sonde.
- 5) Berühren Sie das zu prüfende Objekt mit der roten Messspitze.
- 6) Wenn die Kontrollleuchte aufleuchtet, bedeutet dies die gemessene Position für den Außenleiter, bitte seien Sie vorsichtig.

Beim schwachen Signal, leuchtet die grüne Anzeige auf, der Summer piept in einem langsamen Ton und '-L' wird auf dem Bildschirm angezeigt.

Beim starken Signal erkennt, leuchtet die rote Anzeige auf, der Summer piept schnell und '--H' wird auf dem Bildschirm angezeigt.

Strommessung AC/DC

- 1) Einschalten und Einführen (siehe Seite 30)
- 2) Stecken Sie die rote Sonde in die 'A' Buchse und die schwarze Sonde in die 'COM' Buchse. Das Messgerät stellt sich automatisch auf die 'A \approx ' Messung.
- 3) 'DC' und 'mA' werden auf dem Bildschirm angezeigt und zeigen die Gleichstrommessung an.
- 4) Drücken Sie die 'SEL' Taste, 'mA'-Signal und 'AC'-Signal werden auf dem Bildschirm angezeigt und zeigen die AC-Strommessung an.

Technische Daten

Betriebsspannung	4×1,5V AAA Batterien
Umweltbedingungen	CAT. III 600V ; Verschmutzungsgrad 2; Betriebshöhe< 2000m
MAX. Spannung zwischen Buchsen und Erde	DC/AC 600V
Sicherungsschutz	Sicherung F10A/250V
Betriebstemperatur	0~40 °C (<80% RH, <10 °C nicht kondensierend)
Lagertemperatur	-10~60 °C (<70% RH, Batterie entfernt)
Temperaturkoeffizient	0,1 Genauigkeit /°C (<18°C oder >28°C)
Abtastgeschwindigkeit	3 mal pro Sekunde
Maximale Anzeige	6000 Zähler

Genauigkeit

Zur Wahrung der Genauigkeit sollte die Betriebstemperatur zwischen 18°C und 28°C betragen (<18°C oder >28°C), bei relativer Luftfeuchtigkeit von 0% bis 80%.

Genauigkeit \pm ([% des Messwerts] + [Zähler])

DC-Spannung

Bereich	Auflösung	Genauigkeit
600mV	0,1mV	Eingangsimpedanz: Approx, 10M Ω
6V	0,001V	
60V	0,01V	
600V	1V	

AC-Spannung

Bereich	Auflösung	Genauigkeit
6V	0,001V	Eingangsimpedanz: Approx, 10M Ω
60V	0,01V	
600V	1V	

Frequenzgang: 40Hz~1kHz; 40Hz~1kHz; T-RMS

Widerstand

Bereich	Auflösung	Genauigkeit
600 Ω	0,1 Ω	$\pm(1,0\%+5)$
6 k Ω	0,001 k Ω	
60 k Ω	0,01 k Ω	
600 k Ω	0,1 k Ω	
6 M Ω	0,001 M Ω	
60 M Ω	0,01 M Ω	$\pm(1,5\%+10)$

Überlastschutz: 250V

AC/DC Strom

Bereich	Auflösung	Genauigkeit
600mA	0,1mA	±(1,2%+3)
6A	0,001A	
10A	0,01A	
Überlastschutz: Sicherung F10A/250V Frequenzgang: 40Hz~1 kHz; T-RMS		



Kapazität

Bereich	Auflösung	Genauigkeit
6nF	0,001nF	±(4,0%+5)
60nF	0,01 nF	
600nF	0,1nF	
6 μF	0,001 μF	
60 μF	0,01 μF	
600 μF	0,1 μF	
6mF	0,001 mF	±(5,0%+5)
60mF	0,01 mF	
Überlastschutz: 250V		

Frequenz/Einschaltdauer

Bereich	Auflösung	Genauigkeit
6Hz	0,001Hz	±(1,0%+3)
60Hz	0,01Hz	
600Hz	0,1Hz	
6KHz	0,001 KHz	
60kHz	0,01kHz	
600kHz	0,1kHz	
6MHz	0,001MHz	
10MHz	0,01MHz	
1,0-99,0%	0,1%	±(1,0%+3)
Überlastschutz: 250V		

Dioden/ Durchgang

	Dioden Spannungsabfall anzeigen
	<Ca. ,50Ω, Der Summer ertönt und die Kontrollleuchte leuchtet

Temperatur

Einheit	Auflösung	Genauigkeit
°C	-40°C- 0°C	±3°C
	0°C -1000°C	±2,0% oder ±2°C
°F	-40°F~ 32°F	± 6°F
	32°F- 1832°F	±2,0% orer ±4°F
Auflösung: 1°C/1°F		
HINWEIS: Bitte verwenden Sie eine Thermoelement Sonde		

Wartung

Reinigung

- 1) Schalten Sie das Messgerät aus und entfernen Sie die Messleitungen.
- 2) Wischen Sie das Gehäuse mit einem feuchten Tuch und einem milden Reinigungsmittel ab. Schmutz oder Feuchtigkeit in den Anschlüssen können die Messwerte beeinträchtigen.

Warnung: Halten Sie das Innere des Messgeräts immer sauber und trocken, um Stromschläge oder Schäden zu vermeiden.

Batterien einsetzen

'  ' Signal wird auf dem Bildschirm angezeigt, wenn die Batterie schwach ist.

- 1) Entfernen Sie die Messleitungen vom Messgerät.
- 2) Entfernen Sie die Schraube unter der Taschenlampe und entfernen Sie das Batteriefach.
- 3) Legen Sie 4 x 1,5V AAA-Batterien ein. *Achten Sie beim Einlegen der Batterien auf die Polarität.
- 4) Die Schraube des Batteriefachs anbringen und festziehen.

Warnung:

- Um Stromschläge oder Verletzungen durch falsche Messergebnisse zu vermeiden, ersetzen Sie die Batterie bitte sofort, wenn die Batterie schwach ist.
- Entladen Sie den Akku nicht, indem Sie ihn kurzschließen oder die Polarität vertauschen.

- **Um das Messgerät sicher zu betreiben und zu warten, nehmen Sie bitte die Batterie heraus, wenn es längere Zeit nicht verwendet wird, um zu verhindern, dass das Auslaufen der Batterie das Produkt beschädigt.**

Sicherungen ersetzen

'  ' Signal wird auf dem Bildschirm angezeigt, wenn die Sicherungen durchgebrannt sind, die Stromtestfunktion nicht funktioniert, dann bitte die Sicherungen wechseln.

- 1) Entfernen Sie die Messleitungen vom Messgerät, bevor Sie das Gehäuse oder das Batteriefach öffnen.
- 2) Entfernen Sie die Schraube unter der Taschenlampe und entfernen Sie das Batteriefach.
- 3) Entfernen Sie die durchgebrannten Sicherungen und ersetzen Sie sie durch neue Sicherungen der gleichen Spezifikation. Stellen Sie sicher, dass die Sicherungen in die Sicherungsklemme eingelegt und festgeklemmt sind.
- 4) Die Schraube des Batteriefachs anbringen und festziehen.

Warnung:

- **Verwenden Sie NUR Sicherung mit der angegebenen Stromstärke, Unterbrechung Spannung und Geschwindigkeit.**
- **Verwenden Sie das Messgerät nicht, wenn die hintere Abdeckung geöffnet ist.**

FR Manuel d'instruction

Contenu

Information sur la sécurité	47
Familiarisation avec le produit	50
Aperçu.....	50
Caractéristiques.....	51
Faire des mesures	53
Mode de mesure SMART (AUTO).....	53
Allumez et prêt à l'emploi.....	54
Mode intelligent.....	55
MANUAL measurement mode.....	56
Mesure de tension AC/DC.....	56
Mesure de résistance.....	56
Test de continuité.....	57
Mesure de fréquence/rapport cyclique.....	57
Test de diodes.....	58
Mesure de capacité.....	59
Mesure de température.....	59
Détection de tension AC sans contact.....	60
Détection de ligne de phase.....	60

Mesure de courant AC/DC.....	61
Spécifications.....	62
Spécifications de précision.....	63
Entretien.....	66
Nettoyage.....	66
Installer les piles.....	66
Remplacer les fusibles.....	67

Information sur la sécurité

Le multimètre est conforme à la norme de sécurité contre les surtensions IEC61010-1 CAT.III 600V et au niveau de pollution 2.

Un avertissement identifie les conditions et les procédures qui sont dangereuses pour l'utilisateur.

Avertissement

Pour éviter tout risque d'électrocution, d'incendie ou de blessure :

- Lisez toutes les informations de sécurité avant d'utiliser le produit.
- Ne modifiez pas le produit et utilisez uniquement comme spécifié, ou la protection fournie par le produit peut être compromise.
- Se conformer aux codes de sécurité locaux et nationaux. Utilisez un équipement de protection individuelle (gants en caoutchouc approuvés, protection du visage et vêtements ignifuges) pour éviter les blessures par électrocution et par arc lorsque des conducteurs sous tension dangereux sont exposés.
- Limitez le fonctionnement à la catégorie de mesure, à la tension ou à l'ampérage spécifiés.
- Utilisez des accessoires de catégorie de mesure (CAT), de tension et d'ampérage approuvés

par le produit (sondes, cordons de test et adaptateurs) pour toutes les mesures.

- Ne touchez pas aux tensions >30V CA RMS, 42V CA crête ou 60V CC.
- Utilisez les bornes, la fonction et la plage correctes pour les mesures.
- N'utilisez pas le produit à proximité de gaz explosifs, de vapeurs ou dans des environnements humides ou mouillés.
- N'utilisez pas le produit avec les couvercles retirés ou le boîtier ouvert. Une exposition à des tensions dangereuses est possible.
- Examinez le boîtier avant d'utiliser le produit. Recherchez les fissures ou le plastique manquant. Regardez attentivement l'isolation autour des bornes.
- Débranchez l'alimentation et déchargez tous les condensateurs haute tension avant de mesurer la résistance, la continuité, la capacité ou une jonction de diode.
- Ne pas appliquer plus que la tension nominale, entre les bornes ou entre chaque borne et la terre.
- Débranchez l'alimentation du circuit avant de connecter le produit au circuit lorsque vous mesurez le courant. Connectez le produit en série avec le circuit.
- Mesurez d'abord une tension connue pour vous assurer que le produit fonctionne correctement.

- N'utilisez pas de cordons de test s'ils sont endommagés. Examinez les cordons de test pour voir s'il y a une isolation endommagée, du métal exposé ou si l'indicateur d'usure s'affiche. Vérifiez la continuité du fil de test.
- Retirez les signaux d'entrée avant de nettoyer le produit.
- Lors de la mesure, veuillez d'abord connecter le fil neutre ou de terre, puis le fil de phase; lorsqu'il est déconnecté, veuillez d'abord déconnecter le fil de phase, puis le fil neutre ou de terre.
- Retirez la sonde du multimètre avant d'ouvrir le boîtier ou le couvercle des piles. N'utilisez pas le multimètre lorsqu'il est démonté ou que le couvercle des piles est ouvert.
- Le multimètre ne peut être utilisé qu'avec la sonde fournie pour répondre aux exigences de la norme de sécurité. Si la sonde est endommagée et doit être remplacée la sonde du même modèle et spécification électrique.







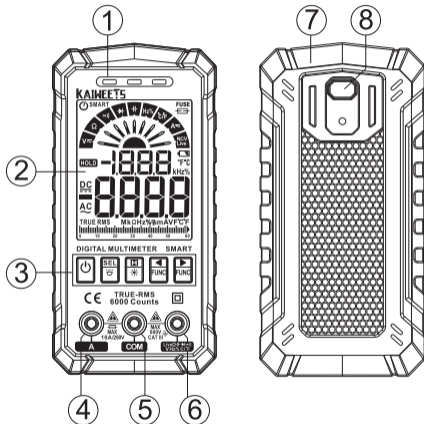









Familiarisation avec le produit







Aperçu

- ① Indicateur d'alarme
- ② Écran LCD
- ③ Boutons de fonction
- ④ Prise d'entrée de courant
- ⑤ Prise COM
- ⑥ Prise pour d'autres fonctions
- ⑦ Capteur NCV
- ⑧ Lampe de poche



Caractéristiques

Bouton	Fonction
	<p>Appuyez le bouton '  ' pendant environ 2 secondes pour allumer/éteindre le multimètre. La mise sous tension est en mode SMART par défaut.</p>
 	<p>Appuyez le bouton '  ' pour sélectionner les fonctions de droite à gauche. Appuyez le bouton '  ' pour sélectionner les fonctions de gauche à droite. Appuyez le bouton '  ' ou '  ' pendant environ 2 secondes pour revenir au mode SMART.</p>
 ST600X  ST600Y	<p>Appuyez le bouton '  ' / '  ' pour activer/désactiver la conservation des données. Appuyez le bouton '  ' pendant environ 2 secondes pour activer/désactiver le rétroéclairage. *Uniquement ST600X.</p>
	<p>Appuyez le bouton '  ' pour sélectionner les fonctions. *Valable uniquement pour le test de tension, le test de courant et le test NCV/LIVE. Appuyez le bouton '  ' pendant environ 2 secondes pour allumer/éteindre la lampe de poche.</p>

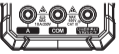
Symbole	Description
 <p>Fusible endommagé</p>	<p>Si le fusible est grillé, le symbole '  ' s'affichera. Dans le test en cours, le symbole ' FUSE ' sera également affiché. Le courant ne peut être mesuré qu'après avoir remplacé le bon fusible.</p>
 <p>Éteindre Automatique</p>	<p>La fonction éteindre automatique par défaut au démarrage et le symbole '  ' s'afficheront.</p> <p>Sans aucune opération dans environ 15 minutes, le multimètre s'éteindra automatiquement. 1 minute avant l'extinction, il y aura 5 bips.</p> <p>Appuyez et maintenez enfoncés les boutons '  ' et '  ' pour allumer le compteur, la fonction Éteindre Automatique sera annulée. Le symbole '  ' n'est pas affiché.</p>
 <p>Indicateur de prise</p>	<p>Lors du passage à d'autres fonctions, le voyant au-dessus de la prise correspondante clignotera pour que les utilisateurs puissent insérer les bons cordons de test dans la bonne prise.</p>

Faire des mesures

Lors de la connexion des cordons de test au circuit ou à l'appareil, connectez le cordon de test commun (COM) avant de connecter le cordon de phase; lors du retrait des cordons de test, retirez le cordon sous tension avant de retirer le cordon de test commun.



Avertissement

- **Ne mesurez pas la tension supérieure à 600V, sinon le multimètre pourrait être endommagé.**
- **Faites attention lors de la mesure de haute tension pour éviter les chocs électriques ou les blessures.**
- **Avant utilisation, testez la tension ou le courant connu pour confirmer que le multimètre est en bon état.**

Mode de mesure SMART (AUTO)

Le multimètre passe par défaut en mode SMART. En mode SMART, le multimètre peut tester la tension continue, la tension alternative, la résistance, la continuité, il sélectionne automatiquement la plage avec la meilleure résolution.

Allumez et prêt à l'emploi

1. Appuyez longuement pendant environ 2 secondes sur le bouton '  ' pour allumer, ' **Auto** ' s'affichera à l'écran et le pointeur se balancera tout seul, indiquant le mode SMART.
2. Insérez la sonde rouge dans la prise ' **Live**  ' et la sonde noire dans la prise ' **COM** '.
VHz% C/F
3. Touchez le fil de test rouge et le fil de test noir pour vérifier s'ils sont normaux. Le buzzer émettra un bip et le voyant s'allumera s'il est normal.

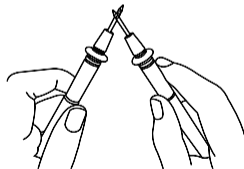
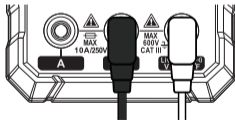

Mode intelligent

Connectez les cordons de test aux deux extrémités du circuit ou de la résistance (en parallèle), le multimètre sélectionne automatiquement la mesure en fonction de l'entrée.

REMARQUE:

La tension minimale mesurable en mode SMART est de 0,8V.

Lors de la mesure de la résistance, si la valeur de la résistance est inférieure à 50Ω , le multimètre émettra un bip et l'indicateur s'allumera.



Tension AC



Tension DC





Résistance





Continuité

MANUAL Measurement Mode

Le multimètre passe par défaut en mode SMART. En mode SMART, appuyez le bouton '' ou '' pour passer en mode manuel et sélectionner la fonction.

Mesure de tension AC/DC

- 1) Allumer et prêt à l'emploi (voir page 54).
- 2) Appuyez le bouton '' pour régler ' $V\sim$ '.
- 3) ' \underline{DC} ' sera affiché sur l'écran, indiquant la mesure de la tension continue.
- 4) Appuyez le bouton '' pour tester la tension alternative, ' \underline{AC} ' sera affiché sur l'écran, indiquant la mesure de la tension alternative.



Mesure de résistance

- 1) Allumer et prêt à l'emploi (voir page 54).
 - 2) Appuyez le bouton '' pour sélectionner ' Ω '.
- ' Ω ' sera affiché sur l'écran, indiquant la mesure de la résistance.



REMARQUE:

Ne mesurez pas directement la résistance interne des micromètres, galvanomètres, batteries et autres instruments.

Test de continuité



- 1) Allumer et prêt à l'emploi (voir page 54).
- 2) Appuyez le bouton '  ' pour régler '  ', indiquant la mesure de continuité.
- 3) Connectez les cordons de test aux deux extrémités du circuit à tester (en parallèle).
- 4) Si la résistance du circuit ou de la résistance testée est inférieure à 50 et que le circuit est en position, le buzzer émettra un bip et un voyant lumineux s'allumera et l'écran affichera la valeur de résistance mesurée.

Mesure de fréquence/rapport cyclique

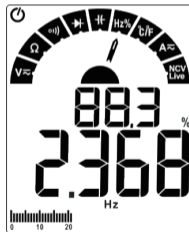
- 1) Allumer et prêt à l'emploi (voir page 54).
- 2) Appuyez le bouton '  ' ou '  ' pour régler ' Hz%' , ' Hz ' et ' % ' sera affiché sur l'écran, indiquant test de fréquence/ de rapport cyclique.



Test de diodes

- 1) Allumer et prêt à l'emploi (voir page 54).
- 2) Appuyez le bouton '  ' pour régler '  ', indiquant le test de la diode.
- 3) Connectez le fil de test rouge avec la polarité positive de la diode, le fil de test noir avec la polarité négative de la diode.
- 4) Si les cordons de test sont connectés à l'envers avec la polarité de la diode, ' OL ' s'affichera.

Bonne diode



| 1.782 |
v

| .OL |
v

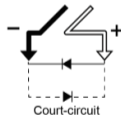

Mauvaise diode



| .OL |
v

| 0.000 |
v



Mesure de capacité

- 1) Allumer et prêt à l'emploi (voir page 54).
- 2) Appuyez le bouton '  ' ou '  ' pour régler '  ', ' nF ' sera affiché sur l'écran, indiquant test de capacité.

* Avant de mesurer le condensateur, déchargez le condensateur pour éviter d'endommager le multimètre.

* Si la capacité est grande, cela peut prendre beaucoup de temps pour que la lecture se stabilise.

Mesure de température

- 1) Allumer et prêt à l'emploi (voir page 54).
- 2) Insérez le pôle positif du thermocouple de type K dans la prise '  ' et le pôle négatif dans la prise ' COM '.
- 3) Appuyez le bouton '  ' ou '  ' pour régler ' °C/°F ', ' °C ' et ' °F ' sera affiché sur l'écran, indiquant test de température.
- 4) Touchez l'objet mesuré.
- 5) La lecture peut prendre quelques secondes pour être stable.

Détection de tension AC sans contact



- 1) Allumer et prêt à l'emploi (voir page 54).
- 2) Appuyez le bouton '  ' pour régler ' **NCV/LIVE** ', ' **NCV** ' sera affiché sur l'écran.
- 3) Rapprocher progressivement la sonde NCV du point à tester.



Lorsque le multimètre détecte un signal faible, l'indicateur vert s'allume, le buzzer émet un bip lent et ' **--L** ' s'affiche à l'écran.

Lorsque le multimètre détecte un signal fort, l'indicateur rouge s'allume, le buzzer émet un bip rapide et ' **--H** ' s'affiche à l'écran.

Détection de ligne de phase

- 1) Allumer et prêt à l'emploi (voir page 54).
- 2) Appuyez le bouton '  ' pour régler ' **NCV/LIVE** ' mode.
- 3) Appuyez le bouton ' **SEL** ' pour régler ' **LIVE** ' mode.
- 4) Insérez la sonde rouge dans la prise ' **Live** () ' et retirez la sonde noire. ' **VHz% C/F** '.
- 5) Touchez l'objet avec le point du fil de test.
- 6) Lorsque le voyant s'allume, cela signifie la position mesurée pour la ligne de phase, soyez prudent !

Mesure de courant AC/DC

- 1) Allumer et prêt à l'emploi (voir page 54).
- 2) Insérez la sonde rouge dans la prise 'A' et la sonde noire dans la prise 'COM'. Le multimètre s'ajustera automatiquement à la 'A \approx '.
- 3) 'DC' et 'mA' sera affiché sur l'écran, indiquant la mesure du courant continu.
- 4) Appuyez le bouton 'SEL', 'mA' et 'AC' sera affiché sur l'écran, indiquant la mesure du courant alternatif.

REMARQUE :

- Lors de la mesure du courant alternatif, la fréquence sera affichée, et lors de la mesure du courant continu, la température ambiante sera affichée sur l'écran.
- 'LEAD' s'affichera à l'écran lorsque les cordons de test sont mal connectés, veuillez insérer le cordon de test rouge dans la prise 'A'.
- Le multimètre passera au test en cours lorsque vous insérez le fil dans la prise 'A' et la prise 'COM'. Pour des raisons de sécurité, les utilisateurs ne peuvent pas changer les fonctions.
- Ne mesurez pas de courant > **10A** dans cet appareil, en cas de fusion du fusible.



Spécifications

Puissance	4×1,5V AAA piles
Conditions environnementales	CAT. III 600V ; Niveau de pollution 2, Altitude < 2000m
MAX. tension entre les bornes et la terre	CC/CA 600V
Protection par fusible	Fusible F10A/250V
Environnement de travail	0-40°C(<80% RH, <10°C sans condensation)
Température de stockage	-10~60°C(<70% RH, retirez la batterie)
Coéfficient de température	0,1 x précision/°C(< 18°C ou >28°C)
Taux d'échantillonnage	Environ. 3 fois/seconde
Affichage	6000 points

Spécifications de précision

La précision est spécifiée pendant 1 an après l'étalonnage, à des températures de fonctionnement de 18°C à 28°C, avec une humidité relative de 0 % à 80 %.

Précision \pm ([% de la lecture] + [Comptes])

Tension continue

Varier	Résolution	Précision
600mV	0,1mV	$\pm(0,5 \% +3)$ Impédance : env.10M Ω
6V	0,001V	
60V	0,01V	
600V	1V	

Tension alternative

Varier	Résolution	Précision
6V	0,001V	$\pm(0,8\%+3)$ Impédance : env.10M Ω
60V	0,01V	
600V	1V	

Réponse en fréquence : 40Hz~1kHz; T-RMS

Résistance

Varier	Résolution	Précision
600 Ω	0,1 Ω	$\pm(1,0\%+5)$
6 k Ω	0,001 k Ω	
60 k Ω	0,01 k Ω	
600 k Ω	0,1 k Ω	
6 M Ω	0,001 M Ω	$\pm(1,5\%+10)$
60 M Ω	0,01 M Ω	

Protection contre les surcharges : 250V

Courant AC/DC

Varier	Résolution	Précision
600mA	0,1mA	$\pm(1,2\%+3)$
6A	0,001A	
10A	0,01A	
Protection contre les surcharges : F10A/250V fuse Réponse en fréquence : 40Hz~1 kHz; T-RMS		



Capacitance

Varier	Résolution	Précision
6nF	0,001nF	$\pm(4,0\%+5)$
60nF	0,01 nF	
600nF	0,1nF	
6 μ F	0,001 μ F	
60 μ F	0,01 μ F	
600 μ F	0,1 μ F	
6mF	0,001 mF	$\pm(5,0\%+5)$
60mF	0,01 mF	
Protection contre les surcharges : 250V		

Fréquence/rapport cyclique

Varier	Résolution	Précision
6Hz	0,001Hz	±(1,0%+3)
60Hz	0,01Hz	
600Hz	0,1Hz	
6KHz	0,001 KHz	
60kHz	0,01kHz	
600kHz	0,1kHz	
6MHz	0,001MHz	
10MHz	0,01MHz	
1,0-99,0%	0,1%	±(1,0%+3)
Protection contre les surcharges : 250V		

Diode/ Continuité

	Chute de tension de la diode d'affichage.
	<Env. 50Ω, l'avertisseur sonore retentira et le voyant lumineux s'allumera.

Température

Unité	Varier	Précision
°C	-40 °C- 0°C	±3°C
	0°C -1000°C	±2,0% ou ±2°C
°F	-40°F~ 32°F	± 6°F
	32°F- 1832°F	±2,0% ou ±4°F
Résolution : 1°C/1°F		
Remarque : veuillez utiliser une sonde thermocouple de type K		

Entretien

Nettoyage

- 1) Coupez l'alimentation du multimètre et retirez les cordons de test.
- 2) Essayez le boîtier avec un chiffon humide et un détergent doux. La saleté ou l'humidité dans les bornes peuvent affecter les lectures.

Avertissement : Gardez toujours l'intérieur de l'appareil propre et sec pour éviter les chocs électriques ou les dommages.

Installer les piles

'  ' sera affiché sur l'écran lorsque la batterie est faible.

- 1) Retirez les cordons de test du multimètre avant d'ouvrir le boîtier ou le couvercle de la batterie.
- 2) Retirez la vis et retirez le couvercle de la batterie.
- 3) Installez 4 x 1,5V AAA batterie. *Veuillez faire attention à la polarité de la batterie.
- 4) Puis inséré dans la porte de la batterie. Installez et serrez la vis du couvercle de la batterie.

Avertissement

- **Pour éviter les chocs électriques ou les blessures causées par une mauvaise lecture, veuillez remplacer la batterie immédiatement lorsque la batterie est faible.**
- **Ne déchargez pas la batterie en la court-circuitant ou en inversant sa polarité.**

- **Pour utiliser et entretenir le multimètre en toute sécurité, veuillez retirer la batterie lorsqu'elle n'est pas utilisée pendant une longue période afin d'éviter que la fuite de la batterie n'endommage le produit.**

Remplacer les fusibles

'  ' sera affiché à l'écran lorsque les fusibles sont grillés, la fonction de test de courant ne fonctionne pas, veuillez changer les fusibles.

- 1) Coupez l'alimentation du multimètre et retirez les sondes.
- 2) Retirez la vis fixant le couvercle arrière et retirez le couvercle arrière.
- 3) Retirez le fusible grillé, remplacez-le par un nouveau de la spécification(**F10A/250V fusible**) et assurez-vous que le fusible est installé dans le clip de sécurité et bien serré.
- 4) Install the back cover and fix it with screws.

Avertissement

- **Utilisez UNIQUEMENT un fusible avec les valeurs d'ampérage, de tension d'interruption et de vitesse spécifiées.**
- **N'utilisez pas le multimètre si le couvercle arrière est ouvert.**

ES Manual de instrucción

ÍNDICE

Información de seguridad	70
Información general del producto	73
Versión General.....	73
Funciones.....	74
Mediciones	76
Modo de Medición SMART (AUTO)	77
Encendido & Listo para usar.....	77
Modo Smart.....	78
Modo de Medición Manual	79
Medición de Tensión en CA/CC.....	79
Medición de Resistancia.....	79
Prueba de Continuidad.....	80
Frecuencia/Ciclo de Trabajo.....	80
Prueba de Diodos.....	81
Medición de Capacitancia.....	82
Medición de Temperatura.....	82
Detección de la tensión en CA sin contacto.....	83
Detección de LIVE.....	83

Medición de Amperios en CC/CA.....	84
Especificaciones.....	85
Especificaciones de Precisión.....	86
Mantenimiento.....	89
Limpieza.....	89
Cambiar Pilas.....	89
Cambiar Fusible.....	90

Información de seguridad

Este multimetro cumple con IEC61010-1 CAT.III 600V la norma de seguridad de sobretensión y el nivel de contaminación 2.

Las advertencias identifica condiciones y procedimientos que son peligrosos para el usuario.

Advertencia

Para evitar posibles descargas eléctricas, incendios o lesiones personales:

- Lea atentamente los símbolos de seguridad antes de utilizar el instrumento. Consérvese esta instrucción para futuras consultas. Entréguelo a sus posibles propietarios futuros.
- No modifique el Producto y utilícelo solo como se especifica, o la protección proporcionada por el Producto puede verse comprometida.
- Observe las normas de seguridad locales y nacionales. Lleve equipo de protección personal (como guantes de goma, máscaras, ropa ignífuga aprobados, etc.) para evitar lesiones causadas por shock eléctrico o arcos eléctricos cuando está expuesto el conductor vivo peligroso.

- Limite la operación a la categoría de medición, tensión o amperaje especificados.
- Mide utilizando la categoría de medida (CAT) y tensión de producto-aprobado y los accesorios con clasificación de amperaje (sondas, cables de prueba y adaptadores).
- No mide la tensión >30V en CA RMS, 42V en máximo de CA, ó 60V en CC.
- Mida con los correctos terminales, funciones y rangos.
- No use el aparato cerca de gas explosivos, corrientes o ambientes húmedos.
- No opere el Producto sin las cubiertas o la carcasa abierta. Es posible la exposición a tensiones peligrosas.
- Examine la carcasa antes de utilizar el Producto. Busque grietas o plástico faltante. Mire cuidadosamente el aislamiento alrededor de los terminales.
- Desconecte la energía y descargue todos los capacitores de alto voltaje antes de medir resistencia, continuidad, capacitancia o una unión de diodos.
- No mida tensión superior al los rangos entre terminales o entre los terminales y la tierra.
- Desconecte la alimentación del circuito antes de conectar el Producto en el circuito cuando mida

amperios. Conecte el Producto en serie con el circuito.

- Antes de usarlo, pruebe tensión o amperio conocido para confirmar que el instrumento puede funcionar normalmente.
- No utilice cables de prueba si están dañados. Examine los cables de prueba en busca de aislamiento dañado, metal expuesto o si el indicador de desgaste muestra. Verifique la continuidad del cable de prueba.
- Elimine todas las señales de entrada antes de limpiar el Producto.
- Conecte primero el neutro o la tierra, luego conecte la fase cuando mide; Pero desconecte primero la fase, luego el neutro o la tierra cuando desconecte los cables.
- Sólo se quitan los cables de prueba desde el polímetro antes de abrir la caja o la tapa de la pila. No lo utilice cuando el instrumento se desmonta o la tapa de pila abierta.
- El instrumento sólo se puede usar junto con la sonda provista para cumplir con los requisitos de la norma de seguridad. Si la sonda está dañada y reemplazada del mismo modelo y especificación eléctrica.







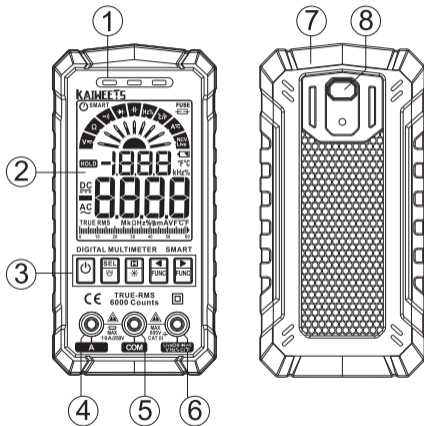









Información general del producto









Vesión General

- ① Indicadora de alarma
- ② LCD Pantalla
- ③ Botones de función
- ④ Terminal de entrada de A
- ⑤ COM Terminal
- ⑥ Terminal de entrada de otras funciones
- ⑦ NCV Sensor
- ⑧ Linterna



Funciones

Botón	Función
	<p>Mantenga presionado el botón '  ' unos 2 segundos para encender o apagar el multímetro. Encendido con SMART modo por defecto.</p>
 	<p>Presione el botón '  ' a seleccionar las funciones desde la derecha hasta la izquierda. Presione el botón '  ' a seleccionar las funciones desde la izquierda hasta la derecha. Mantenga presionado el botón '  ' o '  ' unos 2 segundos para volver al SMART modo.</p>
 ST600X  ST600Y	<p>Presione el botón '  ' / '  ' a activar/desactivar la retención de datos. Mantenga presionado el botón '  ' unos 2 segundos para activar/desactivar la retroiluminación. *ST600X Sólo.</p>
	<p>Presione el botón '  ' a seleccionar funciones. *Sólo válido para la medición de tensión, de amperios y NCV/LIVE prueba. Mantenga presionado el botón '  ' unos 2 segundos para activar/desactivar la linterna.</p>

Símbolo	Descripción
 Fusibles dañados	<p>Si los fusibles fueron quemado, el símbolo '  ' va a mostrar en la pantalla. En la medición de amperios, el símbolo ' FUSE ' también será mostrado, y la medición sólo se puede medir después de reemplazar los fusibles buenos.</p>
 Auto-Apagado	<p>Esta función va a activar por defecto y el símbolo '  ' va a mostrar en la pantalla. Sin operación durante 15 minutos, el multímetro va a apagar automáticamente para ahorrar energía . El zumbador va a sonar 5 veces antes 1 minuto de apagar automáticamente.</p> <p>Mantenga presionado los botones '  ' and '  ' al encender el multímetro, Esta función está cancelado, el símbolo '  ' se desaparece.</p>
 Guía de terminales	<p>Al cambiar a otras funciones, la luz sobre los terminales correspondientes parpadeará para que los usuarios inserten los cables de prueba correctos en el terminal derecho.</p>

Mediciones

Cuando conecta los cable de prueba al circuito o instrumento, conecte las sondas al terminal COM antes de conectar las sondas de Live; Cuando quite los cables, quite el cable de Live antes del cable al terminal COM.

Advertencia

- **No mida una tensión superior a 600V, pues de lo contrario, el instrumento podría dañarse.**
- **Preste especial atención a la seguridad al medir alta tensión para evitar shock eléctrico o lesiones personales.**
- **Antes de usarlo, pruebe un tensión o amperio conocido para confirmar que el instrumento puede funcionar normalmente.**

Modo de medición SMART (AUTO)

El multímetro entra este modo al encender como opción por defecto. En este modo, se permite medir tensión en CC/CA, resistencia, continuidad. Además puede identificar automáticamente los símbolos de medición y seleccionar el más adecuado rango con mayor resolución.

Encendido & Listo para usar

1. Mantenga presionado unos 2 segundos el botón '⏻' a encender el instrumento. 'Auto' se muestra en la pantalla y activa el modo de medición SMART y el puntero se moverá solo, indicando el modo SMART.
2. Conecte el cable de prueba rojo al terminal de entrada 'Live (L) → (V) Hz % C/F' y el negro cable al terminal de 'COM'.
3. Conecte el cable de prueba rojo y el cable de prueba negro para verificar si funciona normalmente. El zumbador sonará y la luz indicadora iluminará si es normal.

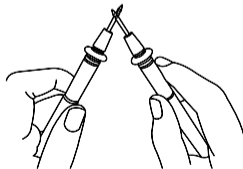
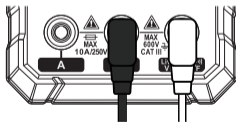

Modo Smart

Conecte las sondas con ambos extremos de la fuente de alimentación medida o la resistencia (en paralelo), y el multímetro reconocerá automáticamente la símbolo medida según la entrada.

NOTA:

La mínima tensión se permite medir en SMART modo es 0,8V.

Al medir la resistencia, si el valor de la resistencia es inferior a 50Ω , el zumbador sonará y la luz indicadora iluminará.

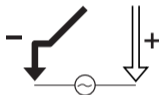

Tensión en CA



Tensión en CC





Resistencia





Continuidad

Modo de Medición Manual

El multímetro entra Modo SMART como opción por defecto. En este modo, Presione el botón '  ' o '  ' para cambiar al modo manual y seleccionar las funcionales.

Medición de Tensión en CA/CC

- 1) Encendido & Listo para usar (véanse la página N°.77)
- 2) Presione el botón '  ' a ' $V \sim$ ' para configurar.
- 3) El símbolo ' \underline{DC} ' va a mostrar en la pantalla, lo significa que la medición de tensión en CC está listo de usar.
- 4) Presione el botón '  ' a la medición de tensión en CA, el símbolo ' \underline{AC} ' va a mostrar en la pantalla, lo significa que la medición de tensión en CA.

Medición de Resistancia



- 1) Encendido & Listo para usar (véanse la página N°.77)
- 2) Presione el botón '  ' a ' Ω ' para configurar.
- 3) El símbolo ' Ω ' va a mostrar en la pantalla, lo significa que la medición de resistencia está listo de usar.

NOTA:

No mida directamente medir nada resistencia interna de micrómetros, galvanómetros, baterías y otros instrumentos.

Prueba de Continuidad

1) Encendido & Listo para usar (véanse la página N°.77)



2) Presione el botón '  ' a ' ) ' para configurar, lo significa que prueba de continuidad está listo de usar.

3) Conecte los cables de prueba a ambos extremos del circuito a probar (en paralelo).

4) Si la resistencia del circuito o resistencia medidos es menor a 50Ω y el circuito está en la posición de encendido, el zumbador sonará y la luz indicadora iluminará y la pantalla mostrará el valor de resistencia medido.



Frecuencia/Ciclo de Trabajo

1) Encendido & Listo para usar (véanse la página N°.77)

2) Presione el botón '  ' o '  ' a la posición ' **Hz%** ' para configurar, el símbolo ' **Hz** ' y ' **%** ' va a mostrar en la pantalla, lo significa que la medición de Frecuencia/Ciclo de trabajo está listo de usar.



Prueba de Diodos

- 1) Encendido & Listo para usar (véanse la página N°.77)
- 2) Presione el botón '  ' a '  ' para configurar, lo significa que prueba de diodos está listo de usar.
- 3) Conecte la sonda del cable de prueba rojo al extremo positivo del diodo y la del negro al extremo negativo del diodo.
- 4) Si la polaridad de la sonda es opuesta a la polaridad del diodo, ' **OL** ' se muestra en la pantalla.

Diodo bueno



| 1.782 |
v

| .OL |
v

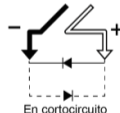

Diodo malo



| .OL |
v



| 0.000 |
v

Medición de Capacitancia

- 1) Encendido & Listo para usar (véanse la página N°.77)
- 2) Presione el botón  ' o '  ' a '  ' para configurar, el símbolo ' **nF** ' va a mostrar en la pantalla, indicando que la medición de capacitancia.

- * Antes de medir el capacitor, descargue el capacitor para evitar daños al instrumento.
- * Si la capacitancia es grande, Si la capacitancia es grande, necesitarás invertir más tiempo a estabilizarse y obtener la lectura.

Medición de Temperatura

- 1) Encendido & Listo para usar (véanse la página N°.77)
- 2) Insert the positive pole of the K-type thermocouple into the ' **Live**  ' jack and the negative pole into the ' **COM** ' jack.
- 3) Presione el botón  ' o '  ' para configurar ' **°C/°F** ', los símbolos ' **°C** ' y ' **°F** ' va a mostrar en la pantalla, indicando la medición de temperatura.
- 4) Conecte la sonda de thermocouple con el objeto medido.
- 5) El valor puede tardar unos segundos a estabilizarse.

Detección de la tensión en CA sin

contacto



- 1) Encendido & Listo para usar (véanse la página N°.77)
- 2) Presione el botón '  ' a ' **NCV/LIVE** ' para configurar, el símbolo ' **NCV** ' va a mostrar en la pantalla.
- 3) Se acerca el sensor NCV al punto probado.



Cuando el instrumento detecta un señal del campo eléctrico débil, La luz indicadora ilumina verde y el zumbador va a sonar a frecuencia lenta. ' --L ' se muestra en la pantalla.

Cuando el instrumento detecta un señal del campo eléctrico fuerte, La luz indicadora luminosa roja y el zumbador va a sonar a frecuencia rápida. ' --H ' se muestra en la pantalla.

Detección de Live

- 1) Encendido & Listo para usar (véanse la página N°.77)
- 2) Presione el botón '  ' a ' **NCV/LIVE** '
- 3) Presione el botón ' **SEL** ' a ' **LIVE** ' modo.
- 4) Conecte el cable de prueba rojo al terminales de entrada '  ' y quite la sonda negra.
- 5) Conecte el objeto bajo prueba con la sonda del cable de prueba rojo.
- 6) Cuando la luz indicadora ilumina, lo significa que la posición medida para la fase tenga cuidado!

Medición de Amperios en CC/CA

- 1) Encendido & Listo para usar (véanse la página N°.77)
- 2) Conecte el cable de prueba rojo al terminales de entrada ' **A** ' y el negro al terminales de ' **COM** '. el multímetro configura automáticamente al parámetro ' **A \approx** '.
- 3) El símbolo ' **DC** ' y ' **mA** ' va a mostrar en la pantalla, indicando la medición de amperios en CC.
- 4) Presione el botón ' **SEL** ', el símbolo ' **mA** ' y ' **AC** ' va a mostrar en la pantalla, indicando la medición de amperios en CA.

Nota:

- Cuando medir la tensión en CA, la frecuencia también se mostrará en la pantalla. Cuando medir la tensión en CC, la temperatura ambiental también se mostrará en la pantalla.
- El símbolo ' **LEAD** ' se mostrará en la pantalla y indicador iluminará rojo cuando los cables de prueba estén conectados equivocados, por favor inserte el cable rojo al terminal de entrada ' **A** '.
- El multímetro cambiará a la medición de amperios cuando conecta el cable al terminal de entrada ' **A** ' y el terminal ' **COM** '. Por motivos de seguridad, los usuarios no pueden cambiar las funciones.
- No mida un amperio > 10A en este parámetro, pues por lo contrario el fusible de 10A va a quemarse.



Especificaciones

Pilas	4 × 1,5V AAA Pilas
Condiciones ambientales	CAT. III 600V ; Nivel de contaminación 2, Altitud < 2000m
La tensión máxima entre los terminales y la tierra	600V en CA/CC
Protección de los fusibles	F10A/250V fusible
Temperatura de operación	0-40°C (<80% RH, <10°C sin condensación)
Temperatura de almacenamiento	-10~60°C (<70% RH, sin pilas)
Coeficiente de temperatura	0,1 x precisión/°C (< 18°C o >28°C)
Frecuencia de muestreo	Aproximadamente 3 veces/segundo
Muestreo	6000 cuentas

Especificaciones de Precisión

La precisión se aplica dentro de un año después de la calibración. la temperatura ambiental desde 18 °C a 28 °C, la humedad relativo es 0 % a 80 %.

Precisión \pm ([% de Lectura] + [Cuentas])

Tensión en CC

Rango	Resolución	Precisión
600mV	0,1mV	$\pm(0,5\% +3)$ Impedancia: Approx.10M Ω
6V	0,001V	
60V	0,01V	
600V	1V	

Tensión en CA

Rango	Resolución	Precisión
6V	0,001V	$\pm(0,8\%+3)$ Impedancia: Approx.10M Ω
60V	0,01V	
600V	1V	

Frecuencia Respuesta: 40Hz~1kHz; T-RMS

Resistencia

Rango	Resolución	Precisión
600 Ω	0,1 Ω	$\pm(1,0\%+5)$
6 k Ω	0,001 k Ω	
60 k Ω	0,01 k Ω	
600 k Ω	0,1 k Ω	
6 M Ω	0,001 M Ω	$\pm(1,5\%+10)$
60 M Ω	0,01 M Ω	

Protección de sobrecarga: 250V

Amperios en CC/CA

Rango	Resolución	Presición
600mA	0,1mA	$\pm(1,2\%+3)$
6A	0,001A	
10A	0,01A	
Protección de sobrecarga: F10A/250V Frecuencia Respuesta de fusibles: 40Hz~1 kHz; T-RMS		



Capacitancia

Rango	Resolución	Presición
6nF	0,001nF	$\pm(4,0\%+5)$
60nF	0,01 nF	
600nF	0,1nF	
6 μ F	0,001 μ F	
60 μ F	0,01 μ F	
600 μ F	0,1 μ F	
6mF	0,001 mF	$\pm(5,0\%+5)$
60mF	0,01 mF	
Protección de sobrecarga: 250V		

Frecuencia/Ciclo de trabajo

Rango	Resolución	Presición
6Hz	0,001Hz	±(1,0%+3)
60Hz	0,01Hz	
600Hz	0,1Hz	
6KHz	0,001 KHz	
60kHz	0,01kHz	
600kHz	0,1kHz	
6MHz	0,001MHz	
10MHz	0,01MHz	
1,0-99,0%	0,1%	±(1,0%+3)
Protección de sobrecarga: 250V		

Diodos/Continuidad

	Se muestra caída de tensión de diodo.
	<Approx. 50Ω,el zumbador va a sonar y ilumina el indicador.

Temperatura

Unidad	Rango	Presición
°C	-40 °C- 0°C	±3°C
	0°C -1000°C	±2,0% o±2°C
°F	-40°F~ 32°F	± 6°F
	32°F- 1832°F	±2,0% o±4°F
Resolución: 1°C/1°F		
Nota: usa los cable de prueba de K-tipo termopar.		

Mantenimiento

Limpieza

- 1) Apague el instrumentos y quite los cables de pruebas.
- 2) Limpie el carcasa exterior con un trapo suave y detergente neutro. La suciedad o la humedad en los terminales pueden afectar los resultados.

Advertencia: Mantenga siempre el interior del medidor limpio y seco para evitar descargas eléctricas o daños.

Cambiar las pilas

El señal '  ' se mostrarán en la pantalla cuando las pilas se agoten.

- 1) Quite los cables de prueba desde instrumento antes de abrir la tapa de base o la tapa de pilas.
- 2) Quite los tornillos la tapa de las pilas.
- 3) Instale 4 x 1,5V AAA pilas. *Preste atención a las polaridad de las pilas.
- 4) Luego instala la tapa de pilas. Instale y apriete el tornillo de la tapa.

Advertencia

- Para evitar descargas eléctricas o lesiones personales causadas por una lectura incorrecta, reemplace las pilas inmediatamente cuando estén agotadas.
- No instale la pila poniéndola en cortocircuito o invirtiendo su polaridad.
- Para operar y mantener el instrumento de manera segura, saque las pilas cuando no se use durante un tiempo prolongado para evitar que la fuga de pilas dañe el producto.

Cambiar Fusible

El señal '  ' se mostrarán en la pantalla, cuando los fusibles están fundidos, la función de medición actual no funciona, cambie los fusibles a tiempo.

- 1) Apague el multímetro y quite los cables de prueba.
- 2) Quite el tornillo debajo de la linterna y quite la tapa de las pilas.
- 3) Quite el fusible quemado, cámbielo por un nuevo con misma especificación(**F10A/250V fuse**). Asegúrese de que el fusible esté instalado en el clip de seguridad y sujeto firmemente.
- 4) Vuelva a colocar la tapa y bloquee la tapa con tornillos.

Advertencia

- Use **ÚNICAMENTE** un fusible con el amperaje, tensión de interrupción y clasificaciones de velocidad especificadas.
- No use el multímetro, si la tapa del instrumento está abierta.

IT Manuale di istruzioni

Contenuti

Informazioni sulla sicurezza	93
Familiarizzazione del prodotto	96
Panoramica.....	96
Caratteristiche.....	97
Effettuare misurazioni	99
Modalità di misurazione SMART (AUTO).....	99
Accendere e pronto all'uso.....	100
Modalità smart.....	101
Modalità di misurazione MANUALE	102
Misura della tensione CA/CC.....	102
Misurazione della resistenza.....	102
Test di continuità.....	103
Misura di frequenza/dovere.....	103
Test dei diodi.....	104
Misura della capacità.....	105
Misurazione della temperatura.....	105
Rilevamento della tensione CA senza contatto.....	106
Rilevamento di fili elettrici.....	106

Misurazione della corrente CA/CC.....	107
Specifiche.....	108
Specifiche di Precisione.....	109
Corrente CA/CC.....	110
Capacità.....	110
Frequenza/Dovere.....	111
Manutenzione.....	112
Pulizia.....	112
Installare la batteria.....	112
Sostituire i fusibili.....	113

Informazioni sulla sicurezza

Il misuratore è conforme allo standard di sicurezza IEC61010-1 CAT.III 600V di sovratensione e al livello di inquinamento 2.

Un'avvertenza identifica le condizioni e le procedure pericolose per l'utente.

Avvertenze

Per prevenire possibili scosse elettriche, incendi o lesioni personali:

- Leggere tutte le informazioni sulla sicurezza prima di usare il Prodotto.
- Non alterare il prodotto e usarlo solo come specificato, altrimenti la protezione fornita dal prodotto può essere compromessa.
- Rispettare i codici di sicurezza locali e nazionali. Usare dispositivi di protezione personale (guanti di gomma approvati, protezioni per il viso e vestiti resistenti alle fiamme) per prevenire scosse e lesioni da esplosione d'arco quando sono esposti conduttori sotto tensione pericolosi.
- Limitare il funzionamento alla categoria di misura, tensione o amperaggio specificati.
- Per tutte le misurazioni utilizzare accessori di categoria di misurazione (CAT), tensione e

amperaggio approvati dal prodotto (sonde, puntali e adattatori).

- Non toccare tensioni >30V CA RMS, 42V CA di picco o 60V CC.
- Usare i terminali, la funzione e l'intervallo corretti per le misurazioni.
- Non utilizzare il prodotto in prossimità di gas o vapori esplosivi o in ambienti umidi o bagnati.
- Non utilizzare il prodotto con i coperchi rimossi o con la custodia aperta. È possibile l'esposizione a tensioni pericolose.
- Esaminare la custodia prima di utilizzare il prodotto. Cercate crepe o plastica mancante. Osservare attentamente l'isolamento intorno ai terminali.
- Scollegare l'alimentazione e scaricare tutti i condensatori ad alta tensione prima di misurare la resistenza, la continuità, la capacità o la giunzione di un diodo.
- Non applicare più della tensione nominale, tra i terminali o tra ogni terminale e la terra.
- Rimuovere l'alimentazione del circuito prima di collegare il Prodotto nel circuito quando si misura la corrente. Collegare il Prodotto in serie al circuito.
- Misurare prima una tensione nota per assicurarsi che il prodotto funzioni correttamente.

- Non utilizzare i puntali se sono danneggiati. Esaminare i puntali in cerca di isolamento danneggiato, metallo esposto o se l'indicatore di usura è visibile. Controllare la continuità dei puntali.
- Rimuovere i segnali di ingresso prima di pulire il prodotto.
- Quando si misura, si prega di collegare prima il filo nullo o di terra, poi il filo vivo; quando si scollega, si prega di scollegare prima il filo vivo e poi il filo nullo o di terra.
- Rimuovere la sonda dal misuratore prima di aprire la custodia o il coperchio della batteria. Non usare lo strumento quando lo strumento è smontato o il coperchio della batteria è aperto.
- Il misuratore può essere utilizzato solo con la sonda fornita per soddisfare i requisiti dello standard di sicurezza. Se la sonda è danneggiata e deve essere sostituita, la sonda dello stesso modello e specifiche elettriche.





Familiarizzazione del prodotto

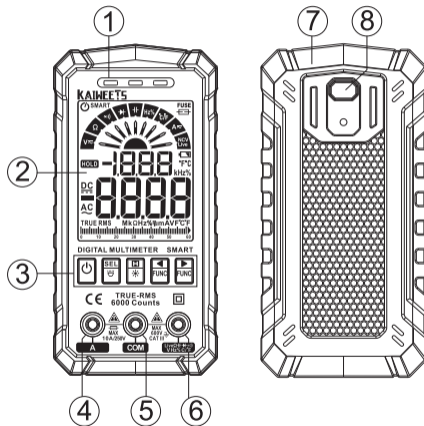







Panoramica

- ① Indicatore di allarme
- ② Schermo LCD
- ③ Pulsanti di funzione
- ④ Ingresso corrente Jack
- ⑤ COM Jack
- ⑥ Jack per altre funzioni
- ⑦ Sensore NCV
- ⑧ Torcia elettrica



Caratteristiche

Pulsante	Funzione
	<p>Premere e tenere premuto il pulsante '⏻' per circa 2 secondi per accendere / spegnere il misuratore. L'accensione è in modalità SMART per impostazione predefinita.</p>
 	<p>Premere il pulsante '← FUNC' per selezionare le funzioni da destra a sinistra. Premere il pulsante 'FUNC →' per selezionare le funzioni da sinistra a destra. Premere il pulsante '← FUNC' o 'FUNC →' per circa 2 secondi per tornare alla modalità SMART.</p>
 <p>ST600X</p>  <p>ST600Y</p>	<p>Premere il pulsante '☑ / ☐' per attivare/disattivare il mantenimento dei dati. Premere il pulsante '☑ *' per circa 2 secondi per accendere/spegnere la retroilluminazione. *Solo ST600X.</p>
	<p>Premere il pulsante 'SEL ☑' per selezionare le funzioni. *Solo valido per la prova di tensione, la prova di corrente e la prova NCV/LIVE. Premere il pulsante 'SEL ☑' per circa 2 secondi per accendere/spegnere la torcia.</p>

Simbolo	Descrizione
 <p>Fusibile danneggiato</p>	<p>Se il fusibile è bruciato, viene visualizzato il simbolo '  '. Nel test della corrente, viene visualizzato anche il simbolo ' FUSE '. La corrente può essere misurata solo dopo aver sostituito il fusibile buono.</p>
 <p>Spegnimento automatico</p>	<p>La funzione di spegnimento automatico di default all'avvio e il simbolo '  ' verrà visualizzato.</p> <p>Senza alcuna operazione per circa 15 minuti, il misuratore si spegnerà automaticamente. 1 minuto prima dello spegnimento, ci saranno 5 segnali acustici.</p> <p>Tenere premuti entrambi i pulsanti '  ' e '  ' per accendere lo strumento, la funzione di spegnimento automatico sarà annullata. Il simbolo '  ' non viene visualizzato.</p>
 <p>Indicazione Jack</p>	<p>Quando si passa ad altre funzioni, la luce sopra il jack corrispondente lampeggerà per permettere agli utenti di inserire i puntali giusti nel jack giusto.</p>

Effettuare misurazioni

Quando si collegano i puntali al circuito o al dispositivo, collegare il puntale comune (COM) prima di collegare il puntale sotto tensione; quando si rimuovono i puntali, rimuovere il puntale sotto tensione prima di rimuovere il puntale comune.



Avvertenze

- **Non misurare la tensione superiore a 600V, altrimenti il misuratore potrebbe essere danneggiato.**
- **Prestare attenzione quando si misura l'alta tensione per evitare scosse elettriche o lesioni personali.**
- **Prima dell'uso, testare la tensione o la corrente nota per confermare che il misuratore è in buone condizioni.**

Modalità di misurazione SMART (AUTO)

Il misuratore passa automaticamente alla modalità SMART. Nella modalità SMART, il misuratore può testare la tensione DC, la tensione AC, la resistenza, la continuità, seleziona automaticamente la gamma con la migliore risoluzione.

Accendere e pronto all'uso

1. Long premere per circa 2 secondi il pulsante '  ' per accendere il Meter, ' **Auto** ' verrà visualizzato sullo schermo, e il puntatore oscillerà da solo, indicando la modalità SMART.
2. Inserire la sonda rossa nella presa ' **Live**  ' e la sonda nera nella presa ' **COM** '.
VHz% C/F
3. Toccare il puntale rosso e il puntale nero per controllare se sono normali. Il cicalino suonerà e l'indicatore luminoso sarà acceso se normale.

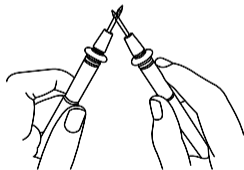
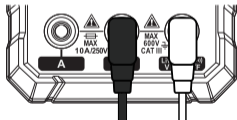

Modalità smart

Collegare i puntali con entrambe le estremità del circuito o della resistenza (in parallelo), il misuratore seleziona automaticamente la misura in base all'ingresso.

NOTA:

La tensione minima misurabile in modalità SMART è 0,8V.

Quando si misura la resistenza, se il valore della resistenza è inferiore a 50Ω , il misuratore emetterà un segnale acustico e l'indicatore si accende.

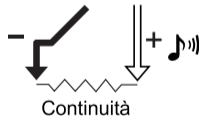
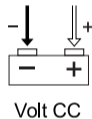
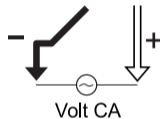



Modalità di misurazione MANUALE

Il misuratore è impostato di default sulla modalità SMART. Nella modalità SMART, premere il pulsante

'' o '' per passare alla modalità manuale e selezionare la funzione.

Misura della tensione CA/CC

- 1) Accendere e pronto per l'uso (guardare a pagina 100)
- 2) Premere il pulsante '' per ' $V\sim$ ' impostazione,
- 3) ' \underline{DC} ' segnale sarà visualizzato sullo schermo, indicando la misura di tensione CC.
- 4) Premere il pulsante '' per la prova di tensione CA, il segnale ' \underline{AC} ' sarà visualizzato sullo schermo, indicando la misura della tensione CA.



Misurazione della resistenza

- 1) Accendere e pronto per l'uso (guardare a pagina 100)
- 2) Premere il pulsante '' per selezionare la marcia ' Ω '. Il segnale ' Ω ' sarà visualizzato sullo schermo, indicando la misurazione della resistenza.



NOTA:

Non misurare direttamente la resistenza interna di micrometri, galvanometri, batterie e altri strumenti.

Test di continuità



- 1) Accendere e pronto all'uso (guardare a pagina 100)
- 2) Premere il pulsante '  ' alla regolazione ' ) ' , indicando la misura di continuità.
- 3) Collegare i puntali alle due estremità del circuito in prova (in parallelo).
- 4) Se la resistenza del circuito o del resistore in prova è inferiore a 50 e il circuito è in posizione, il cicalino emette un segnale acustico e si accende una spia, e lo schermo visualizza il valore della resistenza misurata.

Misura di Frequenza/Dovere

- 1) Accendere e pronto all'uso (guardare a pagina 100)
- 2) Premere il pulsante '  ' o ' Hz% ' all'impostazione '  ' , il segnale ' Hz ' e il segnale ' % ' saranno visualizzati sullo schermo, indicando la prova di frequenza/ rapporto di dovere.



Test dei diodi

- 1) Accendere e pronto all'uso (guardare a pagina 100)
- 2) Premere il pulsante '  ' all'impostazione '  ', indicando il test del diodo.
- 3) Collegare il puntale rosso con la polarità positiva del diodo, il puntale nero con la polarità negativa del diodo.
- 4) Se i puntali sono collegati in modo inverso rispetto alla polarità del diodo, verrà visualizzato ' OL '.

Buon diodo



Diodo difettoso

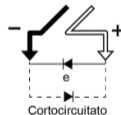

| 1.782 |
v



| .OL |
v

| .OL |
v

| 0.000 |
v

Misura della Capacità

1) Accendere e pronto all'uso (guardare a pagina 100)

2) Premere il pulsante  ' o ' .

all'impostazione '  ', il segnale ' **nF** ' sarà visualizzato sullo schermo, indicando la prova di capacità.



* Prima di misurare il condensatore, scaricare il condensatore per evitare danni al misuratore.

* Se la capacità è grande, la lettura può richiedere molto tempo per stabilizzarsi.

Misurazione della Temperatura

1) Accendere e pronto all'uso (guardare a pagina 100)

2) Inserire il polo positivo della termocoppia di tipo K nella presa '  ' e il polo negativo nella presa ' **COM** '.

3) Premere il pulsante  ' o '  ' a ' **°C/°F** ' impostazione, ' **°C** ' segnale e ' **°F** ' segnale sarà visualizzato sullo schermo, indicando la prova di temperatura.

4) Toccare l'oggetto da misurare.

5) La lettura può richiedere alcuni secondi per essere stabile.

Rilevamento della Tensione CA Senza Contatto

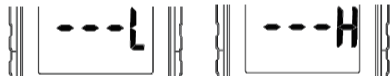

- 1) Accendere e pronto all'uso (guardare a pagina 100)
- 2) Premere il pulsante '  ' per ' **NCV/LIVE** ' impostazione, ' **NCV** ' segnale sarà visualizzato sullo schermo.
- 3) Avvicinare gradualmente la sonda NCV al punto da testare.



Quando il misuratore rileva un segnale debole, l'indicatore verde si accende, il cicalino emette un tono lento e sullo schermo appare ' ---L '.

Quando il misuratore rileva un segnale forte, l'indicatore rosso si accende, il cicalino emette un tono veloce e sullo schermo appare ' --H '.

Rilevamento di Fili Elettrici

- 1) Accendere e pronto all'uso (guardare a pagina 100)
- 2) Premere il pulsante '  ' per ' **NCV/LIVE** '
- 3) Premere il pulsante ' **SEL** ' in modalità ' **LIVE** '.
- 4) Inserire la sonda rossa nella presa '  ' e rimuovere la sonda nera.
- 5) Toccare l'oggetto con la punta del puntale.
- 6) Quando la luce dell'indicatore si accende, significa che la posizione misurata per la linea del fuoco, si prega di fare attenzione!

Misurazione della Corrente CA/CC

- 1) Accendere e pronto all'uso (guardare a pagina 100)
- 2) Inserire la sonda rossa nella presa 'A' e la sonda nera nella presa 'COM'. Il misuratore si regolerà automaticamente alla marcia 'A \approx '.
3) 'DC' segnale e 'mA' segnale sarà visualizzato sullo schermo, indicando la misura della corrente CC.
- 4) Premere il pulsante 'SEL', il segnale 'mA' e il segnale 'AC' saranno visualizzati sullo schermo, indicando la misura della corrente CA.

Nota:

- Quando si misura la corrente CA, verrà visualizzata la frequenza, e quando si misura la corrente CC, la temperatura ambiente verrà visualizzata sullo schermo.
- Il segnale 'LEAD' verrà visualizzato sullo schermo quando i puntali sono collegati in modo errato, si prega di inserire il puntale rosso nella presa 'A'.
- Il misuratore passerà al test della corrente quando si inserisce il cavo nella presa 'A' e nella presa 'COM'. Per sicurezza, gli utenti non possono commutare le funzioni.
- Non misurare la corrente > 10A in questo ingranaggio, in caso di bruciatura del fusibile.



Specifiche

Potenza	4 batterie AAA da 1,5 V
Condizioni ambientali	CAT. III 600V; Livello di inquinamento 2, Altitudine < 2000m
MAX. Tensione tra i terminali e la terra	CC/CA 600V
Protezione dei fusibili	Fusibile F10A/250V
Ambiente di lavoro	0-40°C (<80% RH, <10°C non condensante)
Temperatura di conservazione	-10~60°C (<70% RH, rimuovere la batteria)
Coefficiente di temperatura	0,1 x precisione/° C (< 18°C o >28°C)
Frequenza di campionamento	Circa 3 volte/secondo
Display	6000 conteggi

Specifiche di Precisione

La precisione è specificata per 1 anno dopo la calibrazione, a temperature di funzionamento da 18° C a 28° C, con umidità relativa da 0% a 80%.

Precisione \pm ([% della lettura] + [conteggi])

Tensione CC

Gamma	Risoluzione	Precisione
600mV	0,1mV	Impedenza: Circa 10M Ω
6V	0,001V	
60V	0,01V	
600V	1V	

Tensione CA

Gamma	Risoluzione	Precisione
6V	0,001V	Impedance: Approx.10M Ω
60V	0,01V	
600V	1V	
Risposta in frequenza: 40Hz~1kHz; T-RMS		

Resistenza

Gamma	Risoluzione	Precisione
600 Ω	0,1 Ω	$\pm(1,0\%+5)$
6 k Ω	0,001 k Ω	
60 k Ω	0,01 k Ω	
600 k Ω	0,1 k Ω	
6 M Ω	0,001 M Ω	
60 M Ω	0,01 M Ω	$\pm(1,5\%+10)$
Protezione da sovraccarico: 250V		

Corrente CA/CC

Gamma	Risoluzione	Precisione
600mA	0,1mA	$\pm(1,2\%+3)$
6A	0,001A	
10A	0,01A	
Protezione da sovraccarico: Fusibile F10A/250V Risposta in frequenza: 40Hz~1 kHz; T-RMS		



Capacità

Gamma	Risoluzione	Precisione
6nF	0,001nF	$\pm(4,0\%+5)$
60nF	0,01 nF	
600nF	0,1nF	
6 μ F	0,001 μ F	
60 μ F	0,01 μ F	
600 μ F	0,1 μ F	
6mF	0,001 mF	$\pm(5,0\%+5)$
60mF	0,01 mF	
Protezione da sovraccarico: 250V		

Frequenza/Dovere

Gamma	Risoluzione	Precisione
6Hz	0,001Hz	$\pm(1,0\%+3)$
60Hz	0,01Hz	
600Hz	0,1Hz	
6KHz	0,001 KHz	
60kHz	0,01kHz	
600kHz	0,1kHz	
6MHz	0,001MHz	
10MHz	0,01MHz	
1,0-99,0%	0,1%	$\pm(1,0\%+3)$
Protezione da sovraccarico: 250V		

Diode/Continuità

	Caduta di tensione del diodo del display
	<Circa 50Ω, il cicalino suonerà e l'indicatore luminoso sarà acceso.

Temperatura

Unità	Gamma	Precisione
°C	-40 °C- 0°C	$\pm 3^{\circ}\text{C}$
	0°C -1000°C	$\pm 2,0\%$ o $\pm 2^{\circ}\text{C}$
°F	-40°F~ 32°F	$\pm 6^{\circ}\text{F}$
	32°F- 1832°F	$\pm 2,0\%$ o $\pm 4^{\circ}\text{F}$
Risoluzione: 1°C/1°F		
Nota: utilizzare la sonda a termocoppia di tipo K		

Manutenzione

Pulizia

- 1) Spegnerne il misuratore e rimuovere i puntali.
- 2) Pulire la custodia con un panno umido e un detergente delicato. Sporczia o umidità nei terminali possono influenzare le letture.

Attenzione: Tenere sempre l'interno del misuratore pulito e asciutto per evitare scosse elettriche o danni.

Installare la batteria

Il segnale '  ' verrà visualizzato sullo schermo quando la batteria è scarica.

- 1) Rimuovere i puntali dal misuratore prima di aprire la custodia o lo sportello della batteria.
- 2) Togliere la vite e rimuovere lo sportello della batteria.
- 3) Installare 4 batterie AAA da 1,5V. *Si prega di prestare attenzione alla polarità della batteria.
- 4) Poi inserito nello sportello della batteria. Installare e serrare la vite dello sportello della batteria.

Attenzione

- **Per evitare scosse elettriche o lesioni personali causate da una lettura errata, sostituire immediatamente la batteria quando è scarica.**

- **Non scaricare la batteria cortocircuitandola o invertendone la polarità.**
- **Per far funzionare e mantenere il misuratore in modo sicuro, si prega di togliere la batteria quando non viene utilizzato per un lungo periodo per evitare che la perdita della batteria danneggi il prodotto.**

Sostituire i fusibili

Il segnale '  ' verrà visualizzato sullo schermo quando i fusibili sono bruciati, la funzione di test della corrente non funziona, si prega di cambiare i fusibili.

- 1) Spegnerlo lo strumento e rimuovere le sonde.
- 2) Rimuovere la vite che fissa il coperchio posteriore e rimuovere il coperchio posteriore.
- 3) Rimuovere il fusibile bruciato, sostituirlo con uno nuovo della specifica (**F10A/250V fuse**), e assicurarsi che il fusibile sia installato nella clip di sicurezza e bloccato saldamente.
- 4) Installare il coperchio posteriore e fissarlo con le viti.

Attenzione

- **Usare SOLO un fusibile con i valori di amperaggio, tensione di interruzione e velocità specificati.**
- **Non usare lo strumento se il coperchio posteriore è aperto.**

3 Years Warranty

3 years warranty

Garantía de 3 ANOS

Garantie de 3 ans

Drei-Jahren-Garantie

Tre anni di garanzia



support@Kaiweets.com



[@kaiweetstools](https://www.facebook.com/kaiweetstools)



UK Authorized Representative

Company name: YH Consulting Limited

Address: C/O YH Consulting Limited Office 147,
Centurion House, London Road, Staines-upon-
ThamesStaines, Surrey, London, TW18 4AX

Tel: +44 07514-677868

Email: H2YHUK@gmail.com

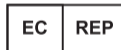

C&E Connection E-Commerce (DE) GmbH

Zum Linnegraben 20, 65933, Frankfurt am Main, Germany

info@ce-connection.de

+49 (069) 27246648